

GROUPE AUSTONI



**SNDPI**

**OUTILS DIAMANT ELECTROGALVANIQUES POUR COUPER :**

**LE PLASTIQUE RENFORCE**

**LES CIRCUITS IMPRIMES**

**LE CARBONE**

**LA CERAMIQUE**

**LES PLASTIQUES LAMINES**

GROUPE AUSTONI

**SNDPI**

**[christian.austoni@wanadoo.fr](mailto:christian.austoni@wanadoo.fr)**

**SNDPI. Zone Artisanale " Les Galinoux - 24100 CREYSSE  
M. AUSTONI Christian 06. 09. 71. 22. 25 // 06. 03. 96. 56.14**

**TEL: (33) 05 53 57 70 52 FAX: (33) 05 53 57 12 90**

Ci-joint notre RIB : 19229 66803 00516403001 68 - IBAN : FR 76 1922 9668 0300 5164 0300 168  
Banco de Sabadell - 77,Av des Champs Elysées - 75008 PARIS



GROUPE AUSTONI

**SNDPI**

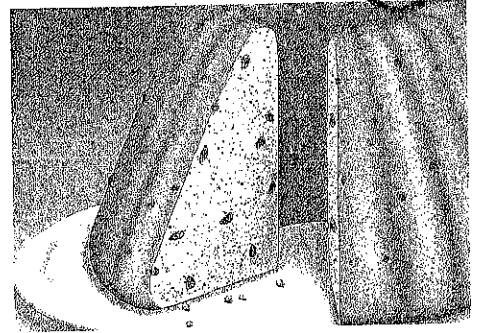

Disques à tronçonner, avec bord chargé

E (mm)	0,10	0,15	0,20	0,25	0,30
T (mm)	0,15	0,20	0,25	0,30	0,40
X (mm)	1,00	2,00	2,00	2,00	2,00
D (mm)					
30	○	○	○	○	○
40	○	○	○	○	○
50	○	○	○	○	○
60	○	○	○	○	○
75	○	○	○	○	○
100	○	○	○	○	○
125				○	○
150				○	○
D/B max	91	126	151	181	252

E (mm)	0,40	0,50	0,60	0,70	0,80
T (mm)	0,50	0,60	0,70	0,80	1,00
X (mm)	2,00	2,00	2,00	2,00	2,00
D (mm)					
30	○	○	○	○	○
40	○	○	○	○	○
50	○	○	○	○	○
60	○	○	○	○	○
75	○	○	○	○	○
100	○	○	○	○	○
125	○	○	○	○	○
150	○	○	○	○	○
D/B max	301	301	301	301	301

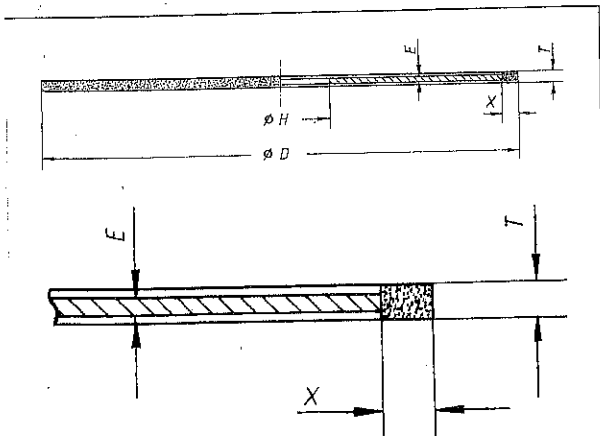

[christian.austoni@wanadoo.fr](mailto:christian.austoni@wanadoo.fr)

SNDPI. Zone Artisanale " Les Galinoux - 24100 CREYSSE  
 M. AUSTONI Christian 06. 09. 71. 22. 25 // 06. 03. 96. 56.14

TEL: (33) 05 53 57 70 52 FAX: (33) 05 53 57 12 90

GROUPE AUSTONI



GROUPE AUSTONI

**SNDPI**



christian.austoni@wanadoo.fr

E (mm)	0,10	0,15	0,20	0,25	0,30
T (mm)	0,15	0,20	0,25	0,30	0,40
X (mm)	1,00	2,00	2,00	2,00	2,00

D (mm)

30	0	0	0	0	0
40	0	0	0	0	0
50	0	0	0	0	0
60	0	0	0	0	0
75	0	0	0	0	0
100	0	0	0	0	0
125				0	0
150				0	0

D max	64	126	151	181	252
-------	----	-----	-----	-----	-----

E (mm)	0,40	0,50	0,60	0,70	0,80
T (mm)	0,50	0,60	0,70	0,80	1,00
X (mm)	2,00	2,00	2,00	2,00	2,00

D (mm)

30	0	0	0	0	0
40	0	0	0	0	0
50	0	0	0	0	0
60	0	0	0	0	0
75	0	0	0	0	0
100	0	0	0	0	0
125	0	0	0	0	0
150	0	0	0	0	0
200	0	0	0	0	0

D max	252	252	252	252	252
-------	-----	-----	-----	-----	-----

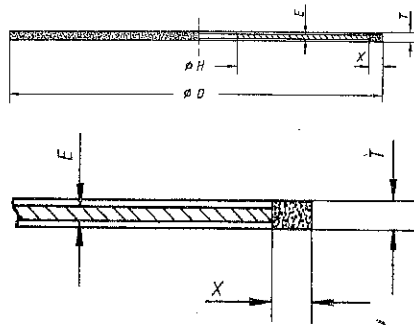

**SNDPI. Zone Artisanale " Les Galinoux - 24100 CREYSSE**  
**M. AUSTONI Christian 06. 09. 71. 22. 25 // 06. 03. 96. 56.14**

**TEL: (33) 05 53 57 70 52 FAX: (33) 05 53 57 12 90**



# GRUPE AUSTONI

# SNDPI

D (mm)	W (mm)	L (mm)
0,9	0,20	12
1,0	0,25	15
1,1	0,30	15
1,2	0,30	18
1,3	0,35	18
1,4	0,40	18
1,5	0,45	18
1,6	0,50	18
1,7	0,55	18
1,8	0,50	20
1,9	0,50	20
2,0	0,50	20
2,5	0,50	22
3,0	0,50	25
3,5	0,50	28
4,0	0,50	30
4,5	0,50	30
5,0	0,50	35
6,0	0,55	35
7,0	0,60	40
8,0	≥ 0,65	40
9,0	≥ 0,70	40
10,0	≥ 0,80	45
12,0	≥ 0,90	47
14,0	≥ 1,00	47
16,0	≥ 1,00	52

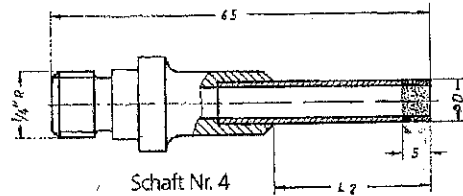
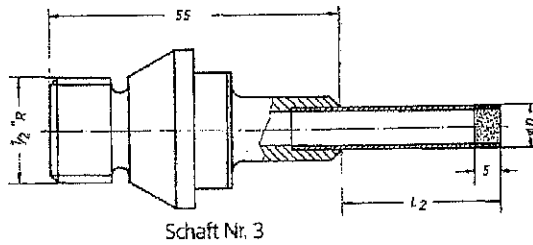
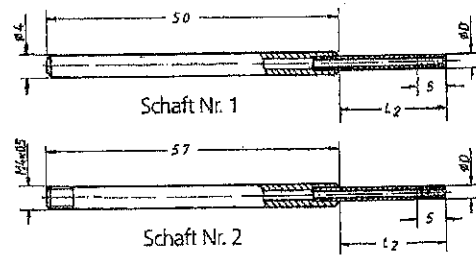
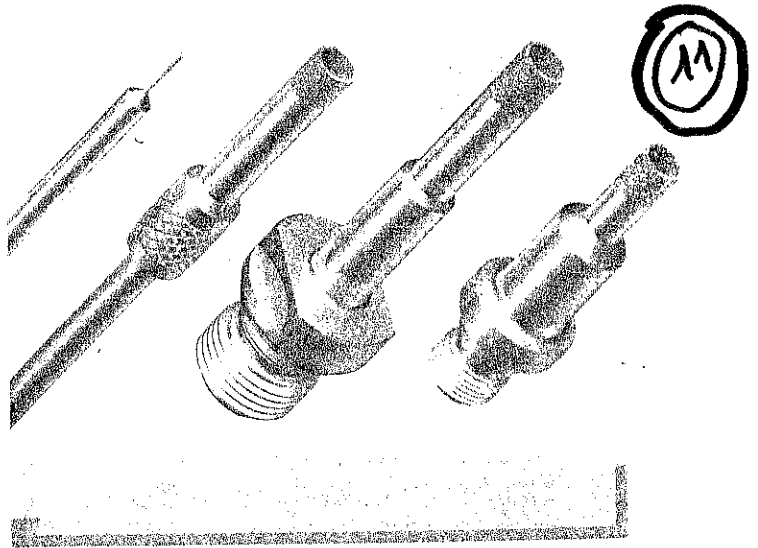

# SNDPI

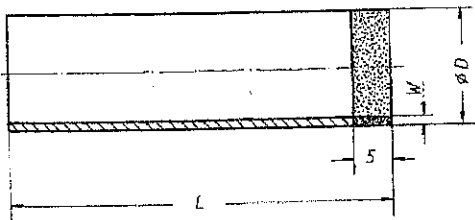

(mm)		
0,9 - 1,1	10	
1,2 - 1,7	13	
1,8 - 2,0	15	
2,1 - 2,4	17	
2,5 - 2,9	20	
3,0 - 3,9	23	
4,0 - 4,9	25	
5,0 - 7,9	30	
8,0 - 9,9	35	
10,0 - 14,9	40	
15,0 - 16,0	45	

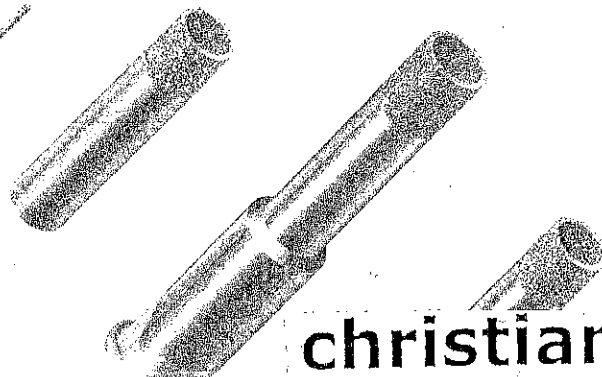

TEL: (33) 05 53 57 70 52

FAX: (33) 05 53 57 12 90

christian.austoni@wanadoo.fr



# GROUPE AUSTONI

# SNDPI



D (mm)	W (mm)	L (mm)
0,9	0,20	12
1,0	0,25	15
1,1	0,30	15
1,2	0,30	18
1,3	0,35	18
1,4	0,40	18
1,5	0,45	18
1,6	0,50	18
1,7	0,55	18
1,8	0,50	20
1,9	0,50	20
2,0	0,50	20
2,5	0,50	22
3,0	0,50	25
3,5	0,50	28
4,0	0,50	30
4,5	0,50	30
5,0	0,50	35
6,0	0,55	35
7,0	0,60	40
8,0	0,65	40
9,0	0,70	40
10,0	0,80	45
12,0	0,90	47
14,0	1,00	47
16,0	1,00	52

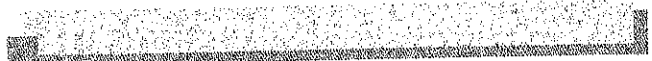
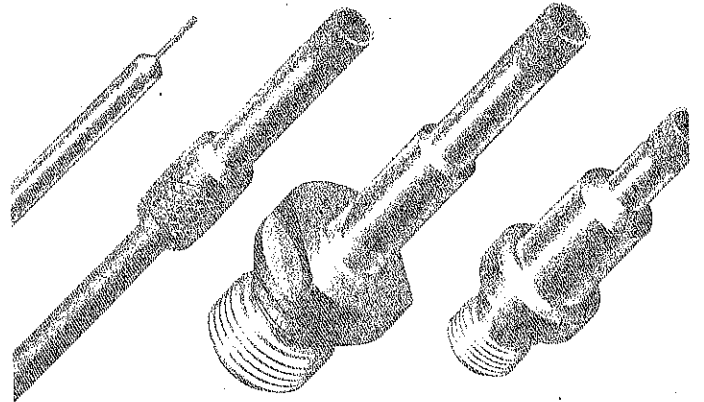

Für ø-Bereich D For ø-range D (mm)	L <sub>2</sub> (mm)
0,9 - 1,1	10
1,2 - 1,7	13
1,8 - 2,0	15
2,1 - 2,4	17
2,5 - 2,9	20
3,0 - 3,9	23
4,0 - 4,9	25
5,0 - 7,9	30
8,0 - 9,9	35
10,0 - 14,9	40
15,0 - 16,0	45

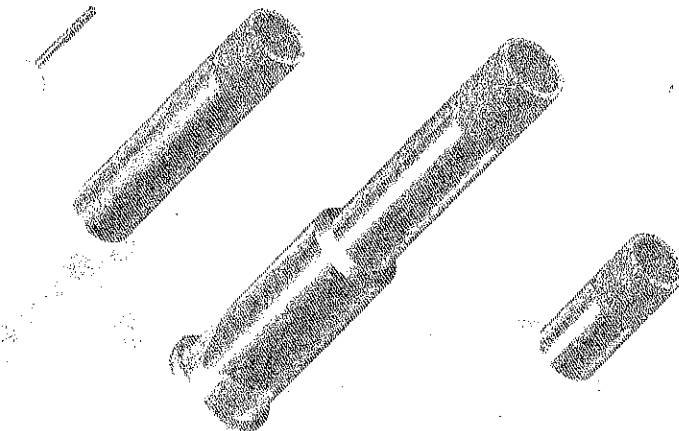
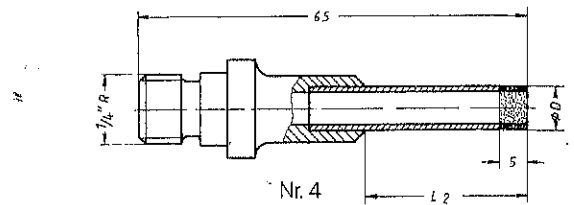
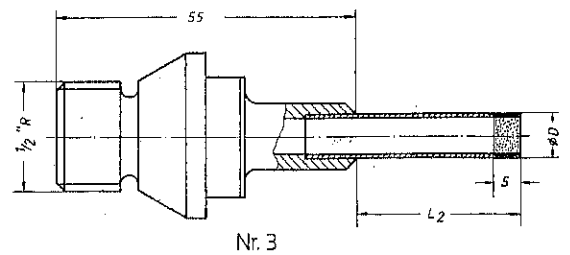
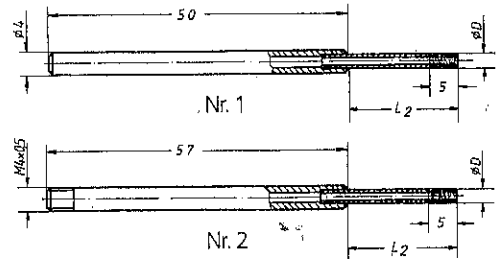
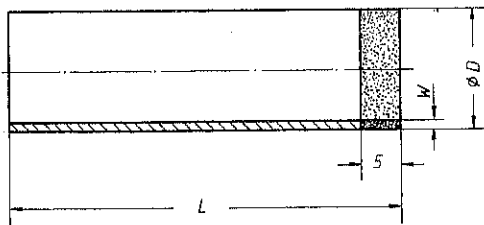

[christian.austoni@wanadoo.fr](mailto:christian.austoni@wanadoo.fr)

SNDPI. Zone Artisanale " Les Galinoux - 24100 CREYSSE  
M. AUSTONI Christian 06. 09. 71. 22. 25 // 06. 03. 96. 56.14

TEL: (33) 05 53 57 70 52 FAX: (33) 05 53 57 12 90



GROUPE AUSTONI

✈ **SNDPI**



# Disques à tronçonner, fendus/dentés

D (mm)	E (mm)	W (mm)	Nombre de segments
150	1,5	2,5	23
200	2,0	2,5	31
225	2,0	2,5	35
250	2,0	2,5	39
275	2,5	2,5	43
300	2,5	2,5	47
350	3,0	2,5	55
400	3,0	2,5	63
450	3,5	2,5	70
500	3,5	2,5	79

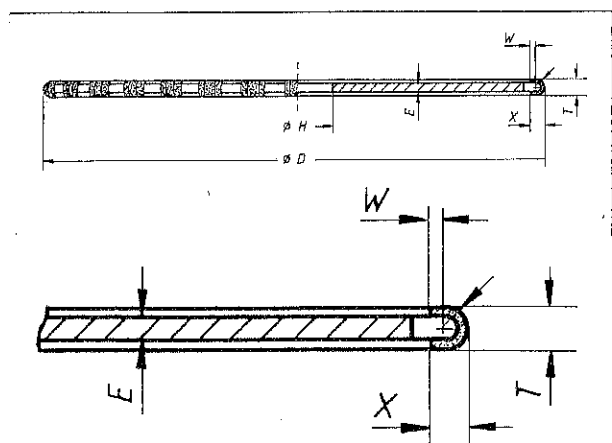
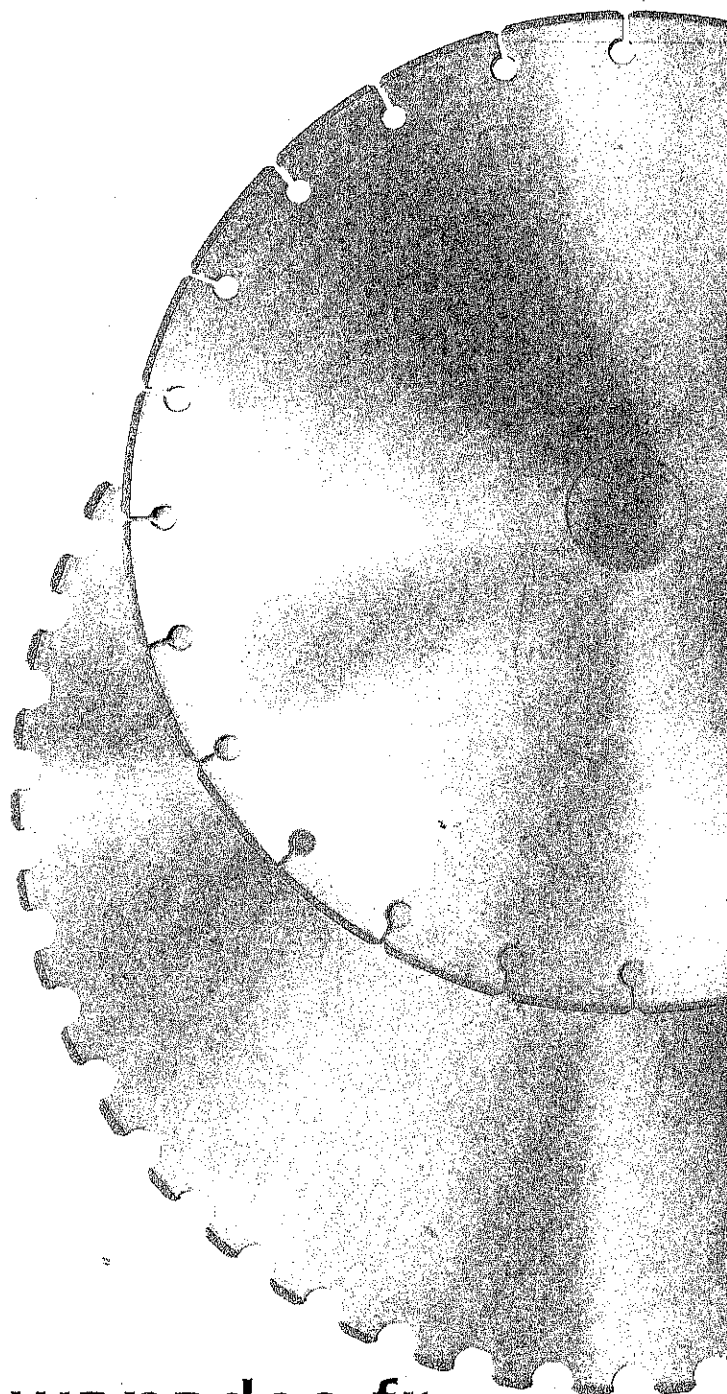

[christian.austoni@wanadoo.fr](mailto:christian.austoni@wanadoo.fr)

**SNDPI. Zone Artisanale " Les Galinoux - 24100 CREYSSE**  
**M. AUSTONI Christian 06. 09. 71. 22. 25 // 06. 03. 96. 56.14**

**TEL: (33) 05 53 57 70 52 FAX: (33) 05 53 57 12 90**



~~4~~ GROUPE AUSTONI

**SNDPI**



christian.austoni@wanadoo.fr

D (mm)	E (mm)	W (mm)	
150	1,5	2,5	23
200	2,0	2,5	31
225	2,0	2,5	35
250	2,0	2,5	39
275	2,5	2,5	43
300	2,5	2,5	47
350	3,0	2,5	55
400	3,0	2,5	63
450	3,5	2,5	70
500	3,5	2,5	79

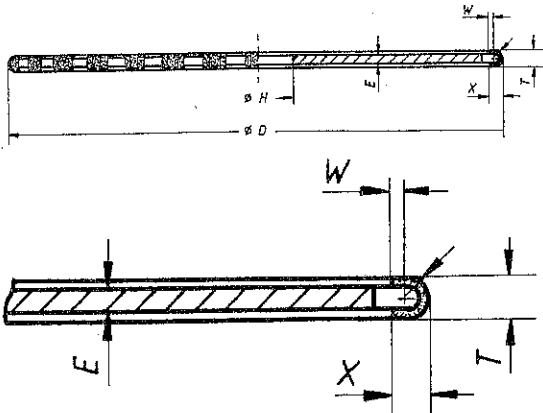
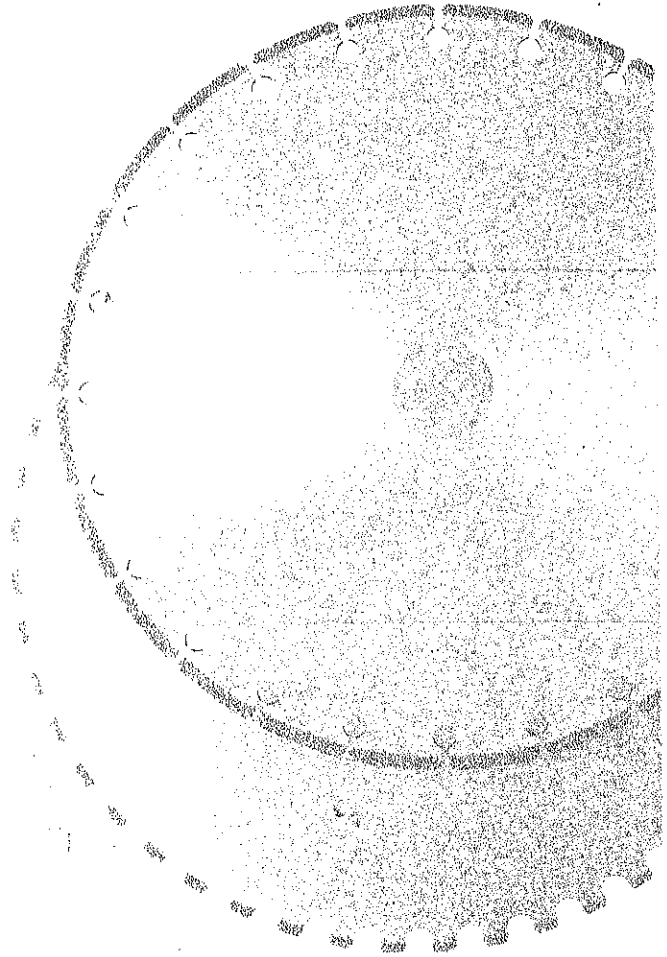

**SNDPI. Zone Artisanale " Les Galinoux - 24100 CREYSSE**  
**M. AUSTONI Christian 06. 09. 71. 22. 25 // 06. 03. 96. 56.14**

TEL: (33) 05 53 57 70 52 FAX: (33) 05 53 57 12 90



GROUPE AUSTONI

**SNDPI**

christian.austoni@wanadoo.fr

D (mm)	E* (mm)	W (mm)
50	0,3	1,0
75	0,5	1,0
100	0,5	1,0
125	0,5	1,5
150	0,5	1,5
175	0,5	1,5
200	0,7	1,5
225	1,0	1,5
250	1,0	1,5
300	1,2	2,5
350	1,5	2,5
400	1,5	2,5
450	2,0	2,5
500	2,0	2,5
550	2,5	2,5
600	2,5	2,5



**SNDPI**

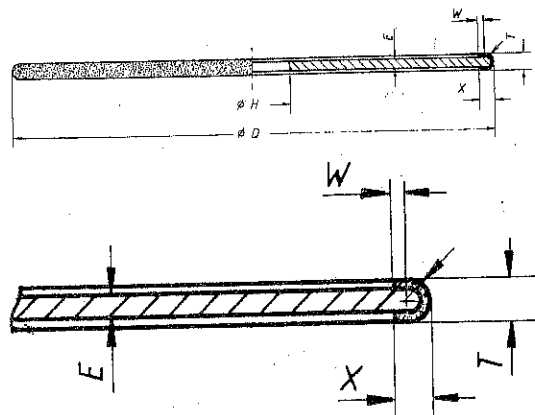

**SNDPI. Zone Artisanale " Les Galinoux - 24100 CREYSSE**  
**M. AUSTONI Christian 06. 09. 71. 22. 25 // 06. 03. 96. 56.14**

TEL: (33) 05 53 57 70 52 FAX: (33) 05 53 57 12 90  
christian.austoni@wanadoo.fr





GROUPPE AUSTONI

**SNDPI**

[christian.austoni@wanadoo.fr](mailto:christian.austoni@wanadoo.fr)

Disques à tronçonner

D (mm)	E* (mm)	W (mm)
50	0,3	1,0
75	0,5	1,0
100	0,5	1,0
125	0,5	1,5
150	0,5	1,5
175	0,5	1,5
200	0,7	1,5
225	1,0	1,5
250	1,0	1,5
300	1,2	2,5
350	1,5	2,5
400	1,5	2,5
450	2,0	2,5
500	2,0	2,5
550	2,5	2,5
600	2,5	2,5

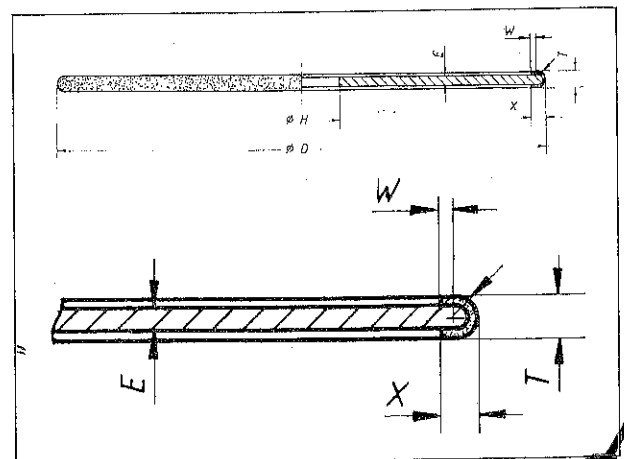
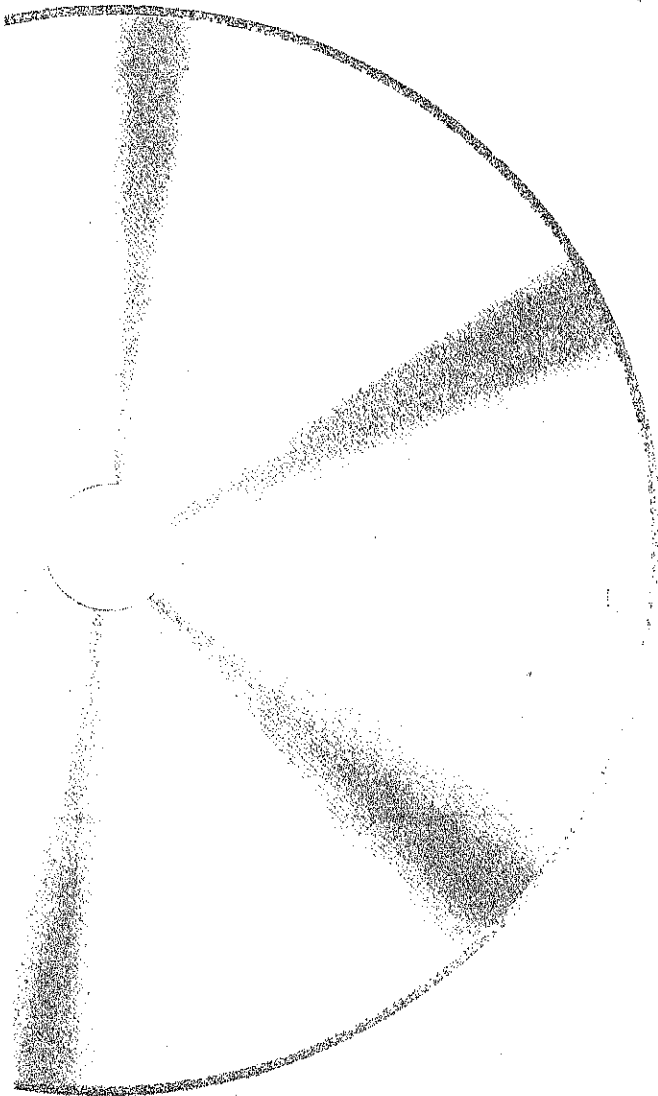

**SNDPI. Zone Artisanale " Les Galinoux - 24100 CREYSSE**  
**M. AUSTONI Christian 06. 09. 71. 22. 25 // 06. 03. 96. 56.14**

**TEL: (33) 05 53 57 70 52 FAX: (33) 05 53 57 12 90**



GROUPE AUSTONI

**SNDPI**

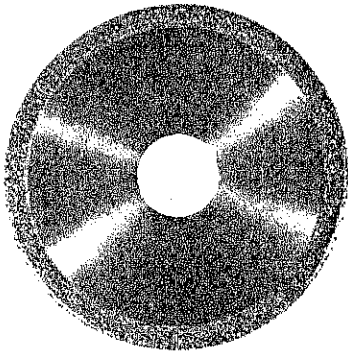

**christian.austoni@wanadoo.fr**

06 09 71 22 25 // 06 03 96 56 14

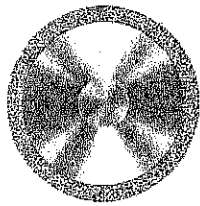

**SNDPI**

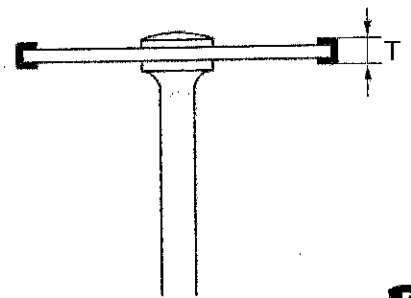

GROUPE AUSTONI



TEL: (33) 05 53 57 70 52 FAX: (33) 05 53 57 12 90

**SNDPI. Zone Artisanale " Les Galinoux - 24100 CREYSSE**  
**M. AUSTONI Christian 06. 09. 71. 22. 25 // 06. 03. 96. 56.14**

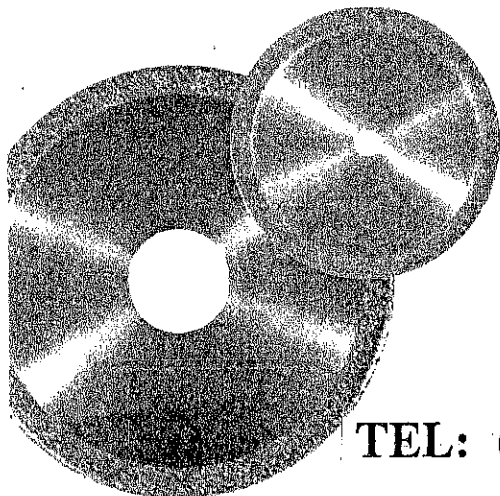

GROUPE AUSTONI

SNDPI

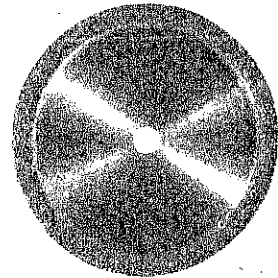
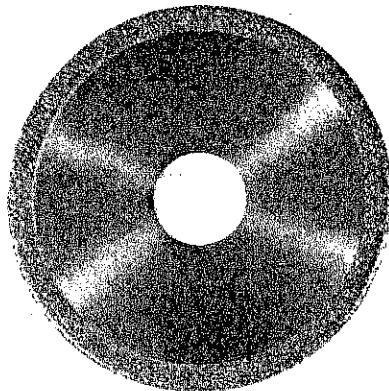

TEL: (33) 05 53 57 70 52 FAX: (33) 05 53 57 12 90

Zone Artisanale "Les Galinoux - 24100 CREYSSSE

D mm	T mm	D76	D107	D181
16	0,30	o		
16	0,40	o		
16	0,50	o		
16	0,50		o	
16	0,60	o		
16	0,60		o	
16	0,70	o		
16	0,70		o	
16	0,70			o
16	0,80	o		
16	0,80		o	
16	0,80			o
16	0,90	o		
16	0,90		o	
16	0,90			o
16	1,00	o		
16	1,00		o	
16	1,00			o
19	0,30	o		
19	0,40	o		
19	0,50	o		
19	0,50		o	
19	0,60	o		
19	0,60		o	
19	0,70	o		
19	0,70		o	
19	0,70			o

GROUPE AUSTONI

D mm	T mm	D76	D107	D181
19	0,80	o		
19	0,80		o	
19	0,80			o
19	0,90	o		
19	0,90		o	
19	0,90			o
19	1,00	o		
19	1,00		o	
19	1,00			o
20	0,30	o		
20	0,40	o		
20	0,50	o		
20	0,50		o	
20	0,60	o		
20	0,60		o	
20	0,70	o		
20	0,70		o	
20	0,70			o
20	0,80	o		
20	0,80		o	
20	0,80			o
20	0,90	o		
20	0,90		o	
20	0,90			o
20	1,00	o		
20	1,00		o	
20	1,00			o

christian.austoni@wanadoo.fr



# GROUPE AUSTONI

# SNDPI

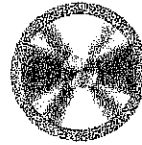
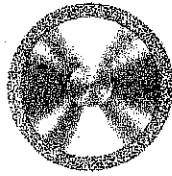
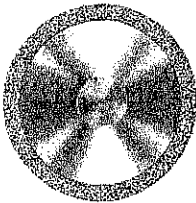

D mm	T mm	D76	D107	D181	D mm	T mm	D76	D107	D181
22	0,30	0			25	0,80	0		
22	0,40	0			25	0,80		0	
22	0,50	0			25	0,80			0
22	0,50		0		25	0,90	0		
22	0,60	0			25	0,90		0	
22	0,60		0		25	0,90			0
22	0,70	0			25	1,00	0		
22	0,70		0		25	1,00		0	
22	0,70			0	25	1,00			0
22	0,80	0			30	0,30	0		
22	0,80		0		30	0,40	0		
22	0,80			0	30	0,50	0		
22	0,90	0			30	0,50		0	
22	0,90		0		30	0,60	0		
22	0,90			0	30	0,60		0	
22	1,00	0			30	0,70	0		
22	1,00		0		30	0,70		0	
22	1,00			0	30	0,70			0
25	0,30	0			30	0,80	0		
25	0,40	0			30	0,80		0	
25	0,50	0			30	0,80			0
25	0,50		0		30	0,90	0		
25	0,60	0			30	0,90		0	
25	0,60		0		30	0,90			0
25	0,70	0			30	1,00	0		
25	0,70		0		30	1,00		0	
25	0,70			0	30	1,00			0

[christian.austoni@wanadoo.fr](mailto:christian.austoni@wanadoo.fr)



SNDPI. Zone Artisanale " Les Galinoux - 24100 CREYSSE  
M. AUSTONI Christian 06. 09. 71. 22. 25 // 06. 03. 96. 56.14

TEL: (33) 05 53 57 70 52 FAX: (33) 05 53 57 12 90

**SNDPI ZA LES GALINOUX 24100 CREYSSE**

TEL: (33) 05 53 57 70 52 FAX: (33) 05 53 57 12 90

**SNDPI**

**GROUPE AUSTONI  
SNDPI**

REFERENCE	DIAMETRE	L 2	T=5	LONGUEUR
FTLC 3,3	3,3	23	5	57
FTLC 3,4	3,4	23	5	57
FTLC 3,5	3,5	23	5	57
FTLC 3,6	3,6	23	5	57
FTLC 3,7	3,7	23	5	57
FTLC 3,8	3,8	23	5	57
FTLC 3,9	3,9	23	5	57
FTLC 4,0	4	25	5	57
FTLC 4,1	4,1	25	5	57
FTLC 4,2	4,2	25	5	57
FTLC 4,3	4,3	25	5	57
FTLC 4,4	4,4	25	5	57
FTLC 4,5	4,5	25	5	57
FTLC 4,6	4,6	25	5	57
FTLC 4,7	4,7	25	5	57
FTLC 4,8	4,8	25	5	57
FTLC 4,9	4,9	25	5	57
FTLC 5	5	30	5	57

**FORETS TIGES LISSES CREUX AVEC BOUTS LISSES OU FILETES M4**

13

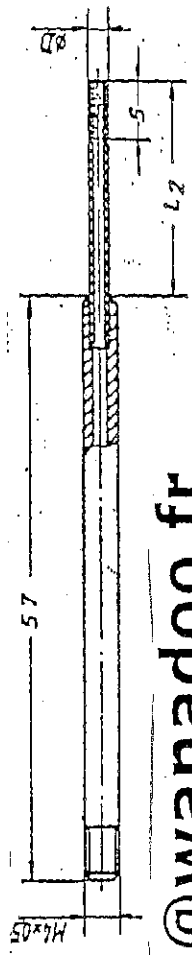

13

[christian.austoni@wanadoo.fr](mailto:christian.austoni@wanadoo.fr)

**SNDPI ZA LES GALINOUX 24100 CREYSSE**

**TEL : 05.53.57.70.52 FAX : 05.53.57.12.90**

**GROUPE AUSTONI  
SNDPI**

REFERENCE	DIAMETRE	L 2	T= 5	LONGUEUR
FTLC 0,9	0,9	10	5	57
FTLC 1	1	10	5	57
FTLC 1,1	1,1	10	5	57
FTLC 1,2	1,2	13	5	57
FTLC 1,3	1,3	13	5	57
FTLC 1,4	1,4	13	5	57
FTLC 1,5	1,5	13	5	57
FTLC 1,6	1,6	13	5	57
FTLC 1,7	1,7	13	5	57
FTLC 1,8	1,8	15	5	57
FTLC 1,9	1,9	15	5	57
FTLC 2,0	2	15	5	57
FTLC 2,1	2,1	17	5	57
FTLC 2,2	2,2	17	5	57
FTLC 2,3	2,3	17	5	57
FTLC 2,4	2,4	17	5	57
FTLC 2,5	2,5	20	5	57
FTLC 2,6	2,6	20	5	57
FTLC 2,7	2,7	20	5	57
FTLC 2,8	2,8	20	5	57
FTLC 2,9	2,9	20	5	57
FTLC 3,0	3	23	5	57
FTLC 3,1	3,1	23	5	57
FTLC 3,2	3,2	23	5	57

**SNDPI**

**FORETS TIGES LISSES CREUX AVEC BOUTS LISSES OU FILETES M4**

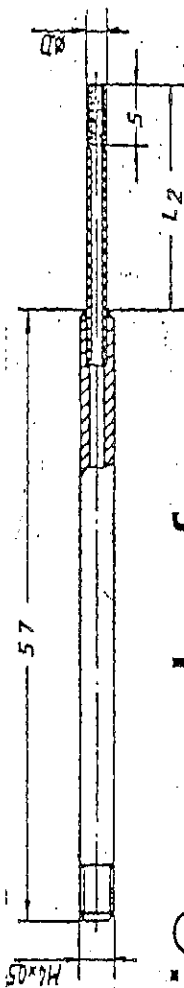

14

14

christian.austoni@wanadoo.fr

**SNDPI ZA LES GALINOUX 24100 CREYSSE**

**TEL : 05 53 57 70 52 - FAX : 05 53 57 12 90**

**FORETS DIAMANT AUTO-CENTRE**

**GROUPE AUSTONI**

**SNDPI**

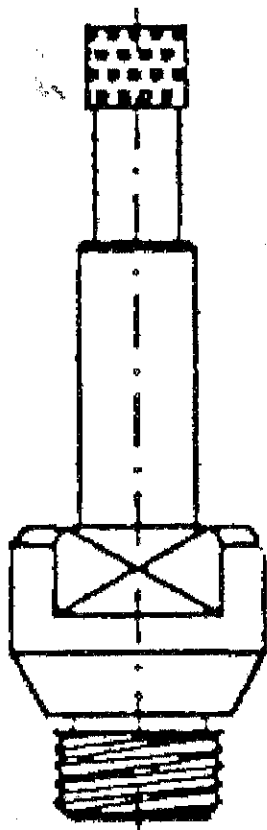

**christian.austoni@wanadoo.fr**

**06 09 71 22 25 // 06 03 96 56 14**

15

REF	D. EXTER	D. INTER	X	L
FAC 3	3	1,5	8	45
FAC 3,5	3,5	1,5	8	45
FAC 4	4	2	8	45
FAC 4,5	4,5	2,5	8	45
FAC 5	5	3	10	45
FAC 5,5	5,5	3,5	10	45
FAC 6	6	4	10	45
FAC 6,5	6,5	4,5	10	45
FAC 7	7	5	10	45
FAC 7,5	7,5	5,5	10	45
FAC 8	8	6	10	45
FAC 8,5	8,5	6,5	10	45
FAC 9	9	7	10	45
FAC 9,5	9,5	7,5	10	45
FAC 10	10	8	10	45
FAC 10,5	10,5	8,5	10	45
FAC 11	11	9	10	45
FAC 11,5	11,5	9,5	10	45
FAC 12	12	10	10	45
FAC 12,5	12,5	10,5	10	45
FAC 13	13	11	10	45
FAC 13,5	13,5	11,5	10	45

REF	D. EXTER	D. INTER	X	L
FAC 14	14	12	10	45
FAC 14,5	14,5	12,5	10	45
FAC 15	15	13	10	45
FAC 15,5	15,5	13,5	10	45
FAC 16	16	14	10	45
FAC 16,5	16,5	14,5	10	45
FAC 17	17	15	10	45
FAC 17,5	17,5	15,5	10	45
FAC 18	18	16	10	45
FAC 18,5	18,5	16,5	10	45
FAC 19	19	17	10	45
FAC 19,5	19,5	17,5	10	45
FAC 20	20	18	10	45
FAC 21	21	19	10	45
FAC 22	22	20	10	45
FAC 23	23	21	10	45
FAC 24	24	22	10	45
FAC 25	25	23	10	45
FAC 26	26	24	10	45
FAC 27	27	25	10	45
FAC 28	28	26	10	45
FAC 29	29	27	10	45

15

**SNDPI ZA LES GALINOUX 24100 CREYSSE**

**TEL : 05 53 57 70 52 - FAX : 05 53 57 12 90**

**FORETS DIAMANT AUTO-CENTRE**

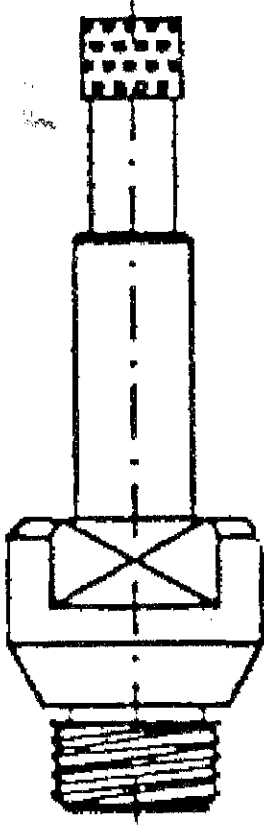

**GROUPE AUSTONI**

**SNDPI**

**christian.austoni@wanadoo.fr**



REF	D. EXTER	D. INTER	X	L
FAC 52	52	50	10	45
FAC 53	53	51	10	45
FAC 54	54	52	10	45
FAC 55	55	53	10	45
FAC 56	56	54	10	45
FAC 57	57	55	10	45
FAC 58	58	56	10	45
FAC 59	59	57	10	45
FAC 60	60	58	10	45
FAC 61	61	59	10	45
FAC 62	62	60	10	45
FAC 63	63	61	10	45
FAC 64	64	62	10	45
FAC 65	65	63	10	45
FAC 66	66	64	10	45
FAC 67	67	65	10	45
FAC 68	68	66	10	45
FAC 69	69	67	10	45
FAC 70	70	68	10	45
FAC 71	71	69	10	45
FAC 72	72	70	10	45
FAC 73	73	71	10	45

REF	D. EXTER	D. INTER	X	L
FAC 30	30	28	10	45
FAC 31	31	29	10	45
FAC 32	32	30	10	45
FAC 33	33	31	10	45
FAC 34	34	32	10	45
FAC 35	35	33	10	45
FAC 36	36	34	10	45
FAC 37	37	35	10	45
FAC 38	38	36	10	45
FAC 39	39	37	10	45
FAC 40	40	38	10	45
FAC 41	41	39	10	45
FAC 42	42	40	10	45
FAC 43	43	41	10	45
FAC 44	44	42	10	45
FAC 45	45	43	10	45
FAC 46	46	44	10	45
FAC 47	47	45	10	45
FAC 48	48	46	10	45
FAC 49	49	47	10	45
FAC 50	50	48	10	45
FAC 51	51	49	10	45





**SNDPI ZA LES GALINOUX 24100 CREYSSE**

**TEL : 05 53 57 70 52 : FAX : 05 53 57 12 90**

**FORETS DIAMANT AUTO-CENTRE**

**GROUPE AUSTONI**

**SNDPI**

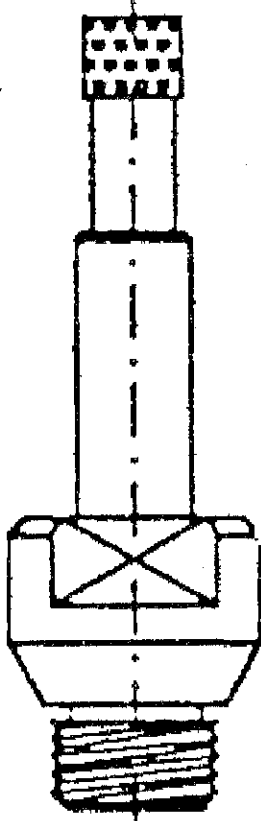

REF	D. EXTER	D. INTER	X	L
FAC 74	74	72	10	45
FAC 75	75	73	10	45
FAC 76	76	74	10	45
FAC 77	77	75	10	45
FAC 78	78	76	10	45
FAC 79	79	77	10	45
FAC 80	80	78	10	45
FAC 81	81	79	10	45
FAC 82	82	80	10	45
FAC 83	83	81	10	45
FAC 84	84	82	10	45
FAC 85	85	83	10	45
FAC 86	86	84	10	45
FAC 87	87	85	10	45

REF	D. EXTER	D. INTER	X	L
FAC 88	88	86	10	45
FAC 89	89	87	10	45
FAC 90	90	87	10	45
FAC 91	91	88	10	45
FAC 92	92	89	10	45
FAC 93	93	90	10	45
FAC 94	94	91	10	45
FAC 95	95	92	10	45
FAC 96	96	93	10	45
FAC 97	97	94	10	45
FAC 98	98	95	10	45
FAC 99	99	96	10	45
FAC 100	100	97	10	45

**POUR TOUTE DIMENSION DECIMALE SUPERIEURE A 20, NOUS CONSULTER**  
**POUR TOUTE DIMENSION SUPERIEURE A 100, NOUS CONSULTER**



# GROUPE AUSTONI

# SNDPI



a) "SVACC" - Svasatori.

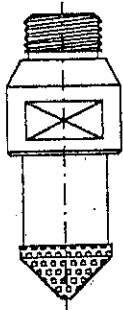

b) "SVATC" - Svasatori.

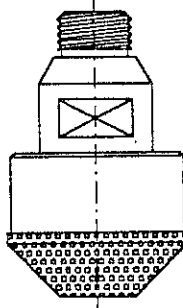

c) FORCI-Forette ciechi

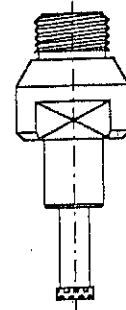

Diam. Minimo	Diam. Massimo
0mm.	15mm.
0mm.	25mm.
0mm.	35mm.
0mm.	45mm.

Diam. Minimo	Diam. Massimo
20mm.	45mm.
40mm.	55mm.
50mm.	65mm.
60mm.	75mm.

Diametro foretto
05 - 06
07 - 08
09 - 10
11 - 12
13 - 14

d) "FRESE" a settori attacco foretto.

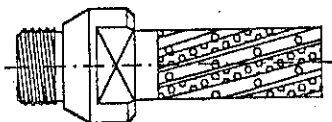

Diam. $\phi$	Altezza	Settori	
		Tipo	Numero
10	27	MM & MD	3
12	40	MM & MD	4
14	40	MM & MD	4
16	40	MM & MD	4
18	40	MM & MD	4
18	40	MM & MD	5
20	40	MM & MD	4
20	40	MM & MD	6
20	55	MM & MD	4

e) "SVASATORI" Gambo 10x30mm.

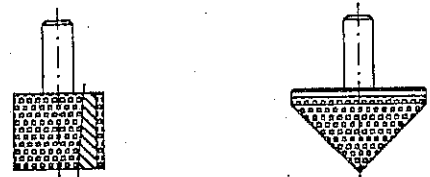

$\phi$  20x25x2,5 (cilindretto)  
.....Prezzo Lire  
 $\phi$  35mm (cono completo 90  
.....Prezzo Lire

f) "MOLETTE" rip. E/C con gambo



Diametro	Altezza	Grana
9 x 35		Grossa D.427
9 x 35		Media D.252
9 x 35		Fine D.181

christian.austoni@wanadoo.fr

SNDPI. Zone Artisanale "Les Galinoux - 24100 CREYSSE  
M. AUSTONI Christian 06. 09. 71. 22. 25 // 06. 03. 96. 56.14

TEL: (33) 05 53 57 70 52 FAX: (33) 05 53 57 12 90



GROUPPE AUSTONI

**SNDPI**



Prodotto: "FORSV" foratori diamantati con svasatore regolabile e accessor

a) - Svasatore completo.

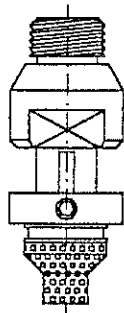

b) Foretto per FORSV.

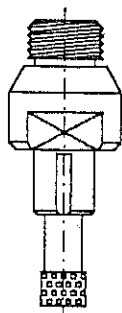

c) Svasatore per FORSV.

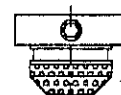

christian.austoni@wanadoo.fr

Diametro foro mm.	Diametro svasatore
04	14
05 - 06	15 - 16
07 - 08	17 - 18
09 - 10	19 - 20
11 - 12	21 - 22
13 - 14	23 - 24
15 - 16	25 - 26
17 - 18	27 - 28
19 - 20	29 - 30
21 - 22	31 - 32
23 - 24	33 - 34
25 - 26	35 - 36
27 - 28	37 - 38
29 - 30	39 - 40
31 - 32	41 - 42
33 - 34	43 - 44
35 - 36	45 - 46
37 - 38	47 - 48
39 - 40	49 - 50
41 - 42	51 - 52
43 - 44	53 - 54
45 - 46	55 - 56
47 - 48	57 - 58
49 - 50	59 - 60
51 - 52	61 - 62
53 - 54	63 - 64
55 - 56	65 - 66
57 - 58	67 - 68
59 - 60	69 - 70
61 - 62	71 - 72
63 - 64	73 - 74
65 - 66	75 - 76
67 - 68	77 - 78
69 - 70	79 - 80

Diametro mm.
04
05 - 06
07 - 08
09 - 10
11 - 12
13 - 14
15 - 16
17 - 18
19 - 20
21 - 22
23 - 24
25 - 26
27 - 28
29 - 30
31 - 32
33 - 34
35 - 36
37 - 38
39 - 40
41 - 42
43 - 44
45 - 46
47 - 48
49 - 50
51 - 52
53 - 54
55 - 56
57 - 58
59 - 60
61 - 62
63 - 64
65 - 66
67 - 68
69 - 70

Svasatore per foro diametro
04
05 - 06
07 - 08
09 - 10
11 - 12
13 - 14
15 - 16
17 - 18
19 - 20
21 - 22
23 - 24
25 - 26
27 - 28
29 - 30
31 - 32
33 - 34
35 - 36
37 - 38
39 - 40
41 - 42
43 - 44
45 - 46
47 - 48
49 - 50
51 - 52
53 - 54
55 - 56
57 - 58
59 - 60
61 - 62
63 - 64
65 - 66
67 - 68
69 - 70

**SNDPI**



SNDPI. Zone Artisanale " Les Galinoux - 24100 CREYSSE  
M. AUSTONI Christian 06. 09. 71. 22. 25 // 06. 03. 96. 56.14

TEL: (33) 05 53 57 70 52 FAX: (33) 05 53 57 12 90

# GROUPE AUSTONI

# SNDPI



Prodotto: "FORST" foratori diamantati a settori ricambiabili.  
 Prodotto: "FORET" foratori diamantati a corona continua.

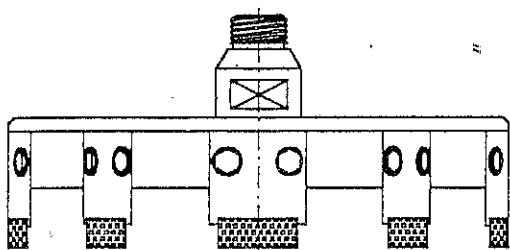

'FORST'

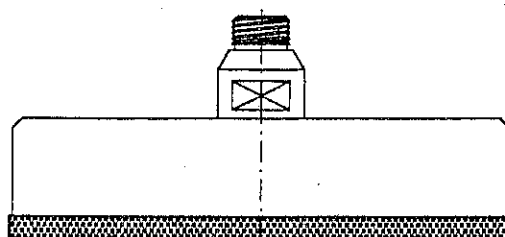

'FORET'

Prezzi validi per foretti tipo: "N" - "A" - "W" - "M" - "H"

**Descrizione**  
 Prezzi validi anche per "FORET" salvo disponibilità stampi

Da diametro 100mm. a diametro 104.90mm. a 6 settori.....
Da diametro 105mm. a diametro 119.90mm. a 7 settori.....
Da diametro 120mm. a diametro 139.90mm. a 8 settori.....
Da diametro 140mm. a diametro 154.90mm. a 9 settori.....
Da diametro 155mm. a diametro 169.90mm. a 10 settori.....
Da diametro 170mm. a diametro 184.90mm. a 11 settori.....
Da diametro 185mm. a diametro 199.90mm. a 12 settori.....
Da diametro 200mm. a diametro 214.90mm. a 13 settori.....
Da diametro 215mm. a diametro 234.90mm. a 14 settori.....
Da diametro 235mm. a diametro 249.90mm. a 15 settori.....
Da diametro 250mm. a diametro 264.90mm. a 16 settori.....
Da diametro 265mm. a diametro 279.90mm. a 17 settori.....
Da diametro 280mm. a diametro 294.90mm. a 18 settori.....
Da diametro 285mm. a diametro 314.90mm. a 19 settori.....
Da diametro 315mm. a diametro 329.90mm. a 20 settori.....
Da diametro 330mm. a diametro 344.90mm. a 21 settori.....
Da diametro 345mm. a diametro 359.90mm. a 22 settori.....
Da diametro 360mm. a diametro 374.90mm. a 23 settori.....
Da diametro 375mm. a diametro 394.90mm. a 24 settori.....
Da diametro 395mm. a diametro 400.00mm. a 25 settori.....

TEL: (33) 05 53 57 70 52 FAX: (33) 05 53 57 12 90

christian.austoni@wanadoo.fr

SNDPI. Zone Artisanale " Les Galinoux - 24100 CREYSSE  
 M. AUSTONI Christian 06. 09. 71. 22. 25 // 06. 03. 96. 56.14



GROUPE AUSTONI

**SNDPI**



[christian.austoni@wanadoo.fr](mailto:christian.austoni@wanadoo.fr)

SNDPI. Zone Artisanale " Les Galinoux - 24100 CREYSSE  
M. AUSTONI Christian 06. 09. 71. 22. 25 // 06. 03. 96. 56.14

Linien Lines	D1 (mm)	D2 (mm)
10	21,2	6,4
12	21,2	7,6
13	21,2	8,2
14	21,2	8,9
15	21,2	9,5
16	21,2	10,2
17	21,2	10,8
18	21,2	11,4
20	21,2	12,7
22	21,2	14,0
24	21,2	15,2
26	21,2	16,5
28	21,2	17,8
30	25,2	19,0
32	25,2	20,3
34	25,2	21,6
36	25,2	22,9
38	25,2	24,1
40	27,8	25,4
42	27,8	26,7
44	27,8	27,9
48	27,8	30,5
50	27,8	31,8
54	27,8	34,3
60	27,8	38,1
70	27,8	44,5

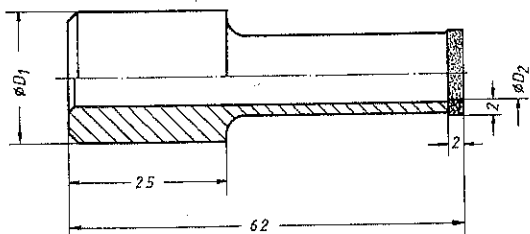
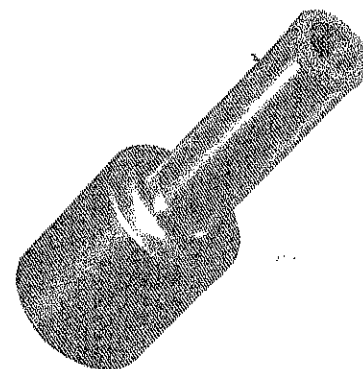
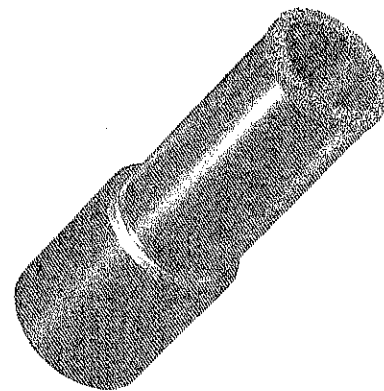
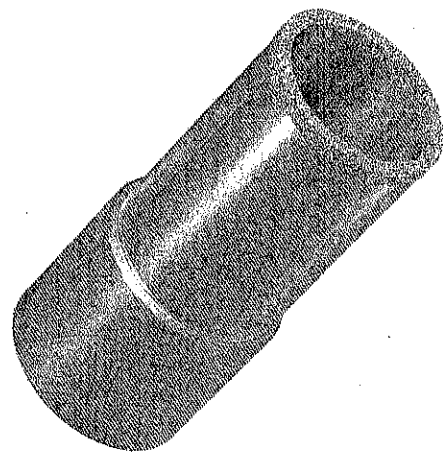

[christian.austoni@wanadoo.fr](mailto:christian.austoni@wanadoo.fr)

SNDPI. Zone Artisanale " Les Galinoux - 24100 CREYSSE  
M. AUSTONI Christian 06. 09. 71. 22. 25 // 06. 03. 96. 56.14

TEL: (33) 05 53 57 70 52 FAX: (33) 05 53 57 12 90

**GROUPE AUSTONI**  
La diversité des idées individuelles.

**SNDPI**

Rodoirs cylindriques 

christian.austoni@wanadoo.fr



Les matériaux fragiles et durs offrent des avantages incomparables et posent en même temps des exigences extrêmes aux outils. Qu'il s'agisse de roues dentées, de composants électroniques ou même de boutons en nacre, des exigences spéciales sont sans cesse posées à vos produits. Pour que vous puissiez usiner les matériaux et pièces les plus divers, les matériaux standards et spé-

D (mm)	T (mm)	Y (mm)	L (mm)	L1 (mm)	L2 (mm)	
3,0	5	3,0	70	49	20	
3,5	5	3,0	75	70	-	
4,0	5	3,5	75	70	-	
4,5	6	4,0	75	69	-	
5,0	7	4,5	75	68	-	
5,5	7	5,0	75	68	-	
6,0	8	5,5	80	72	-	D/B 91
6,5	8	6,0	80	72	-	D/B 126
7,5	8	6,0	80	72	-	D/B 151
8,0	8	6,0	80	72	-	D/B 181
8,5	8	6,0	80	72	-	D/B 252
9,0	10	8,0	100	90	-	
9,5	10	8,0	100	90	-	
10,0	10	8,0	100	90	-	
11,0	10	10,0	110	100	-	
12,0	10	10,0	110	100	-	
13,0	10	10,0	110	100	-	
14,0	10	10,0	110	100	-	
15,0	10	10,0	110	100	-	

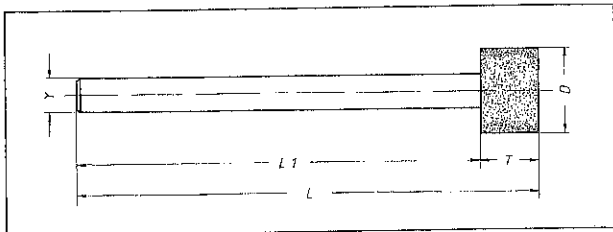

**SNDPI**

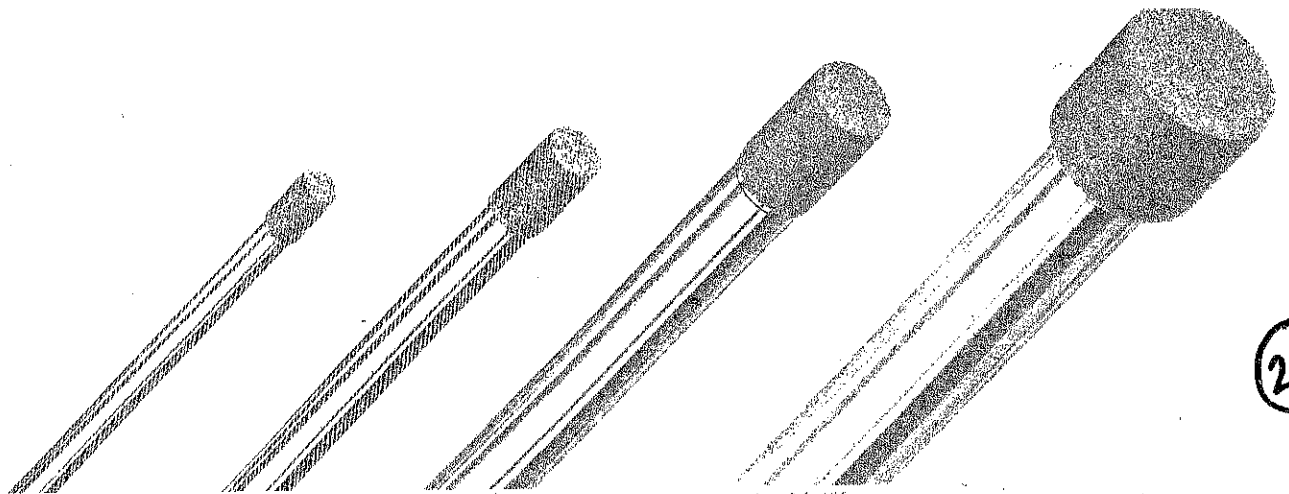



**SNDPI. Zone Artisanale " Les Galinoux - 24100 CREYSSE**  
**M. AUSTONI Christian 06. 09. 71. 22. 25 // 06. 03. 96. 56.14**

**TEL: (33) 05 53 57 70 52 FAX: (33) 05 53 57 12 90**



# GROUPE AUSTONI

# SNDPI

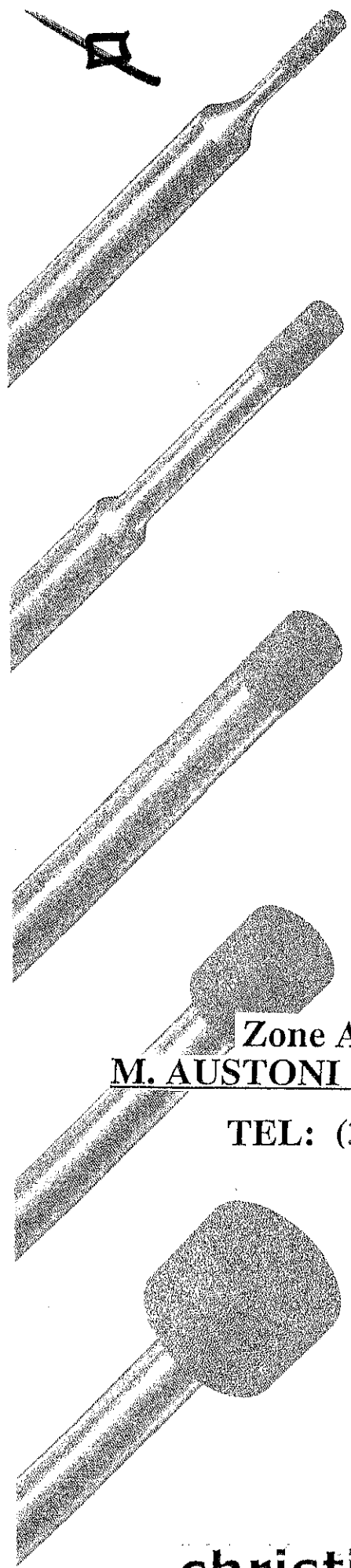

D (mm)	T (mm)	S (mm)	L1 (mm)	L4 (mm)	
0,5	2	3	40	5	
0,6	2	3	40	5	D/B 91
0,6	4	3	40	3	
0,7	2	3	40	5	
0,7	4	3	40	3	
0,8	2	3	40	7	
0,8	4	3	40	5	
0,9	4	3	40	5	D/B 91
1,0	4	3	40	5	D/B 126
1,2	4	3	40	8	D/B 151
1,5	4	3	40	8	
1,7	4	3	40	8	
2,0	4	3	40	12	
2,5	4	3	40	12	
3,0	5	3	40	15	
3,5	5	3	50	-	
4,0	5	3	50	-	
4,5	5	3	50	-	
5,0	7	3	50	-	
6,0	7	6	60	13	
6,0	7	6	80	13	
7,0	8	6	60	-	D/B 91
7,0	8	6	80	-	D/B 126
8,0	10	6	60	-	D/B 151
8,0	10	6	80	-	B 18
10,0	10	6	60	-	B 252
10,0	10	6	80	-	
12,0	10	6	60	-	
12,0	10	6	80	-	
15,0	10	6	60	-	
15,0	10	6	80	-	

**Zone Artisanale " Les Galinoux - 24100 CREYSSE**  
**M. AUSTONI Christian 06. 09. 71. 22. 25 // 06. 03. 96. 56.14**

**TEL: (33) 05 53 57 70 52 FAX: (33) 05 53 57 12 90**

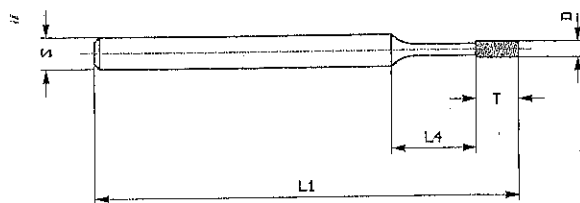

**christian.austoni@wanadoo.fr**



# SNDPI

# GROUPE AUSTONI

24

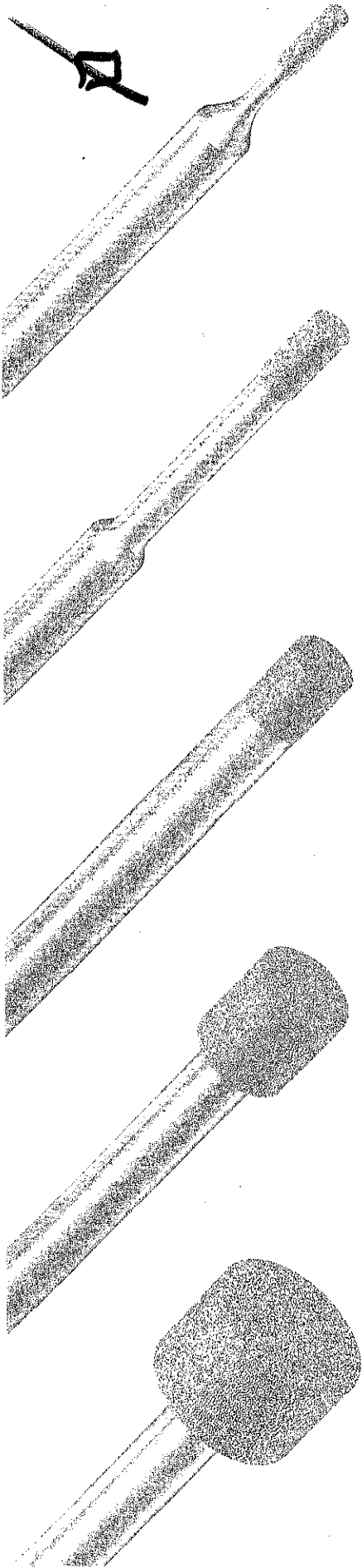

christian.austoni@wanadoo.fr

D (mm)	T (mm)	S (mm)	L1 (mm)	L4 (mm)	
0,5	2	3	40	5	
0,6	2	3	40	5	D/B 91
0,6	4	3	40	3	
0,7	2	3	40	5	
0,7	4	3	40	3	
0,8	2	3	40	7	
0,8	4	3	40	5	
0,9	4	3	40	5	D/B 91
1,0	4	3	40	5	D/B 126
1,2	4	3	40	8	D/B 151
1,5	4	3	40	8	
1,7	4	3	40	8	
2,0	4	3	40	12	
2,5	4	3	40	12	
3,0	5	3	40	15	
3,5	5	3	50	-	
4,0	5	3	50	-	
4,5	5	3	50	-	
5,0	7	3	50	-	
6,0	7	6	60	13	
6,0	7	6	80	13	
7,0	8	6	60	-	D/B 91
7,0	8	6	80	-	D/B 126
8,0	10	6	60	-	D/B 151
8,0	10	6	80	-	B 181
10,0	10	6	60	-	B 252
10,0	10	6	80	-	
12,0	10	6	60	-	
12,0	10	6	80	-	
15,0	10	6	60	-	
15,0	10	6	80	-	

# SNDPI

24

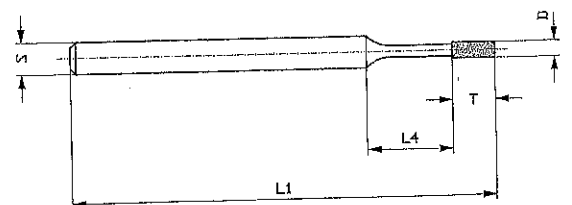

TEL: (33) 05 53 57 70 52 FAX: (33) 05 53 57 12 90





# Rodoirs cylindriques

GROUPE AUSTONI

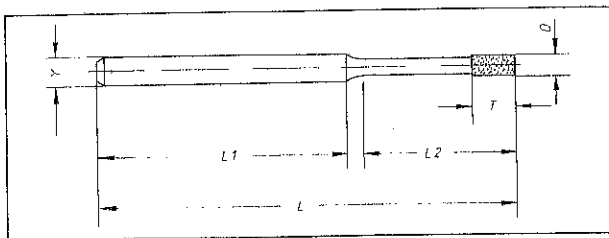
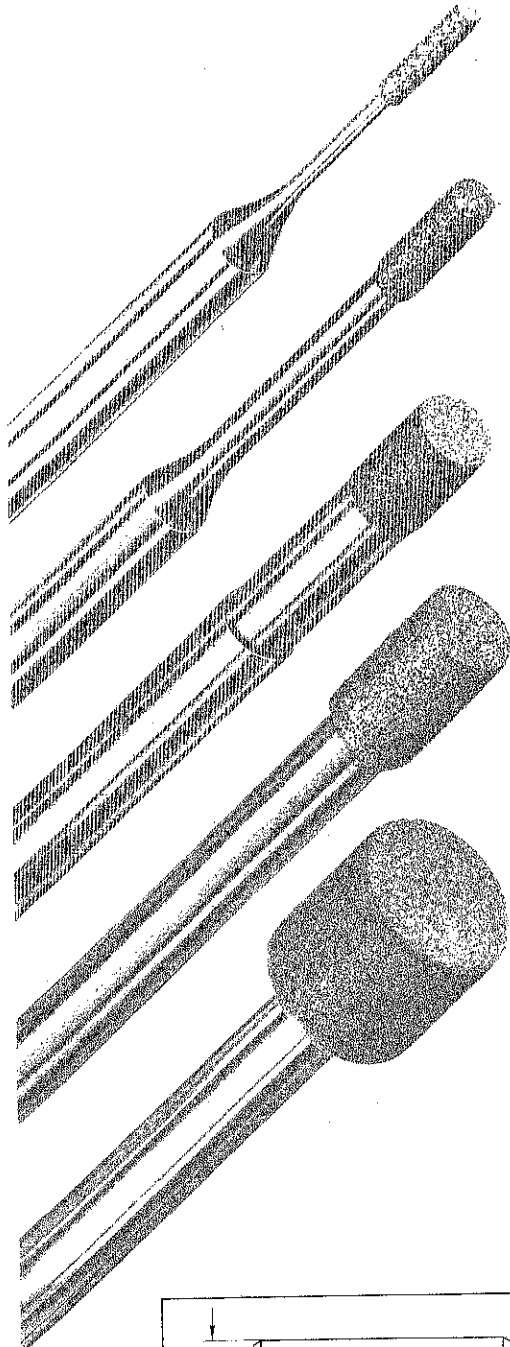

D (mm)	T (mm)	Y (mm)	L (mm)	L1 (mm)	L2 (mm)	
0,5	2	3	40	33	4	
0,6	2	3	40	33	4	D/B 91
0,6	4	3	40	33	4	
0,7	2	3	40	33	4	
0,7	4	3	40	33	4	
0,8	2	3	40	31	6	
0,8	4	3	40	31	6	
0,9	4	3	40	31	6	
1,0	4	3	40	31	6	
1,2	4	3	40	28	9	
1,5	4	3	40	28	9	
1,7	4	3	40	28	10	
2,0	4	3	40	24	14	
2,5	4	3	40	24	14	
3,0	5	3	40	20	19	
3,5	5	3	50	45	-	
4,0	5	3	50	45	-	D/B 91
4,5	5	3	50	45	-	D/B 126
5,0	7	3	50	43	-	D/B 151
6,0	7	6	60	40	19	
6,0	7	6	80	60	19	
7,0	8	6	60	52	-	
7,0	8	6	80	72	-	
8,0	10	6	60	50	-	
8,0	10	6	80	70	-	
10,0	10	6	60	50	-	
10,0	10	6	80	70	-	
12,0	10	6	60	50	-	
12,0	10	6	80	70	-	
15,0	10	6	60	50	-	
15,0	10	6	80	70	-	



[christian.austoni@wanadoo.fr](mailto:christian.austoni@wanadoo.fr)

SNDPI. Zone Artisanale " Les Galinoux - 24100 CREYSSE  
M. AUSTONI Christian 06. 09. 71. 22. 25 // 06. 03. 96. 56.14

TEL: (33) 05 53 57 70 52 FAX: (33) 05 53 57 12 90



**GROUPE AUSTONI**

**SNDPI**

D (mm)	T (mm)	S (mm)	L1 (mm)	L4 (mm)	
3,0	5	3,0	70	16	
3,5	5	3,0	75	-	
4,0	5	3,5	75	-	
4,5	6	4,0	75	-	
5,0	7	4,5	75	-	
5,5	7	5,0	75	-	
6,0	8	5,5	80	-	D/B 91
6,5	8	6,0	80	-	D/B 126
7,5	8	6,0	80	-	D/B 15
8,0	8	6,0	80	-	D/B 18
8,5	8	6,0	80	-	B 252
9,0	10	8,0	100	-	
9,5	10	8,0	100	-	
10,0	10	8,0	100	-	
11,0	10	10,0	110	-	
12,0	10	10,0	110	-	
13,0	10	10,0	110	-	
14,0	10	10,0	110	-	
15,0	10	10,0	110	-	

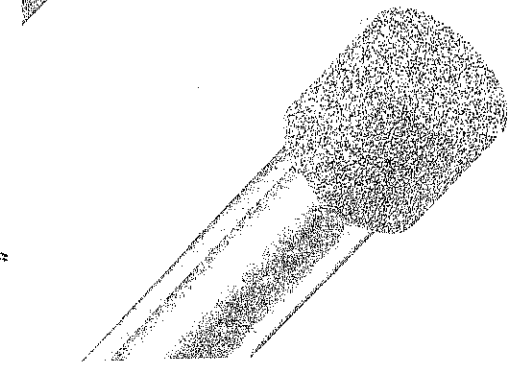
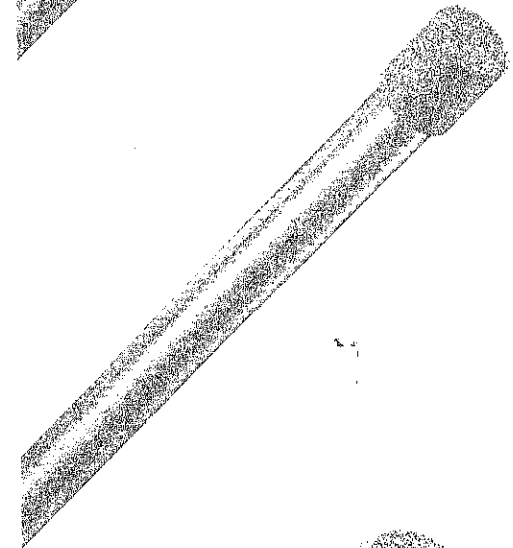
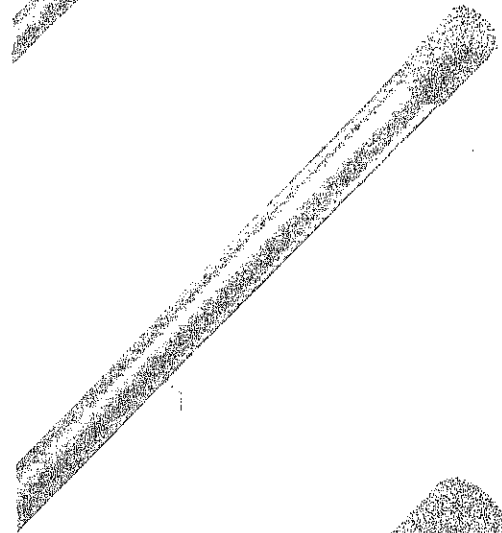
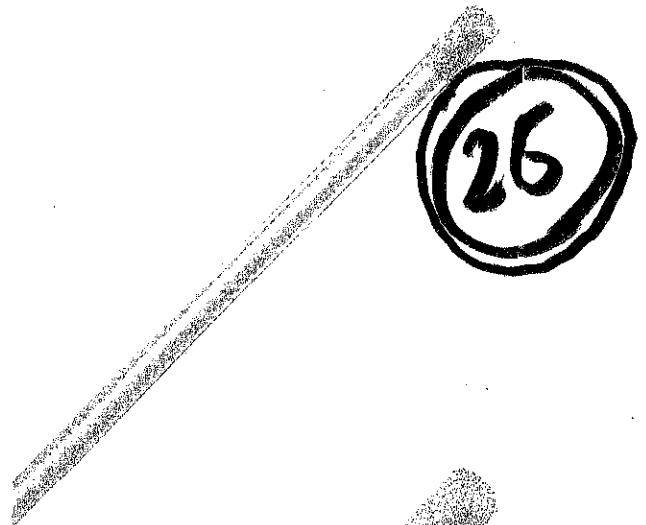

TEL: (33) 05 53 57 70 52 FAX: (33) 05 53 57 12 90

**GROUPE AUSTONI**

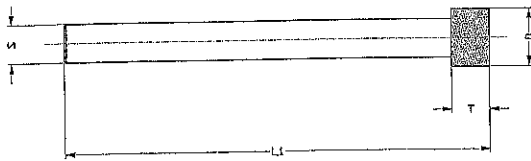

**SNDPI. Zone Artisanale " Les Galinoux - 24100 CREYSSE**  
**M. AUSTONI Christian 06. 09. 71. 22. 25 // 06. 03. 96. 56.14**

TEL: (33) 05 53 57 70 52 FAX: (33) 05 53 57 12 90

**christian.austoni@wanadoo.fr**



# SNDPI

# GROUPE AUSTONI



D (mm)	T (mm)	S (mm)	L1 (mm)	L4 (mm)
3,0	5	3,0	70	16
3,5	5	3,0	75	-
4,0	5	3,5	75	-
4,5	6	4,0	75	-
5,0	7	4,5	75	-
5,5	7	5,0	75	-
6,0	8	5,5	80	-
6,5	8	6,0	80	-
7,5	8	6,0	80	-
8,0	8	6,0	80	-
8,5	8	6,0	80	-
9,0	10	8,0	100	-
9,5	10	8,0	100	-
10,0	10	8,0	100	-
11,0	10	10,0	110	-
12,0	10	10,0	110	-
13,0	10	10,0	110	-
14,0	10	10,0	110	-
15,0	10	10,0	110	-

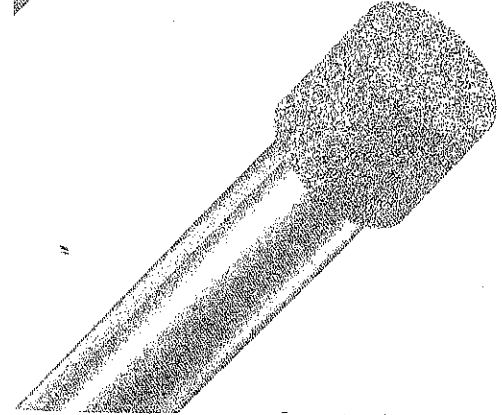
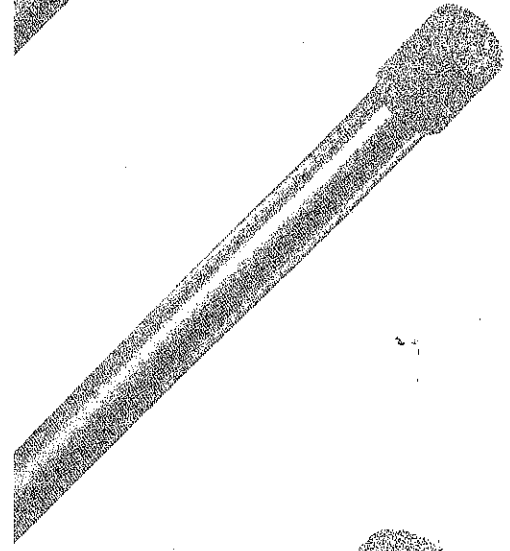
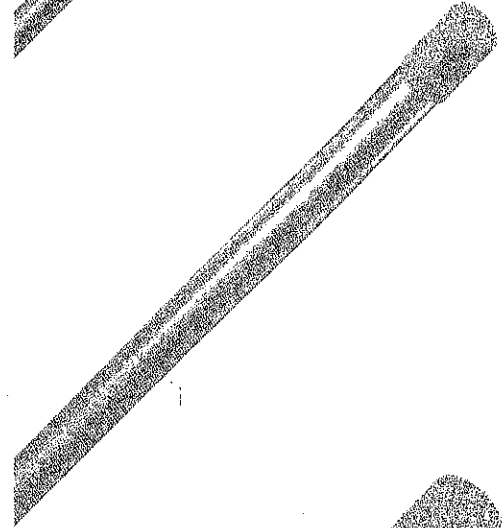
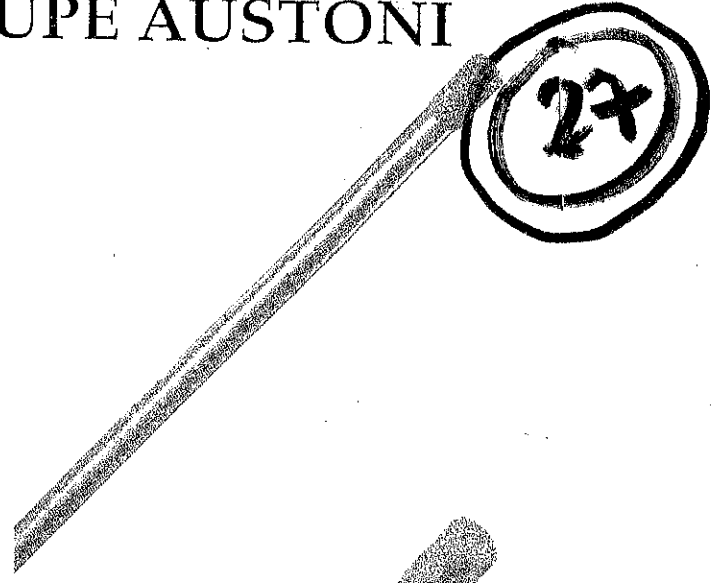

christian.austoni@wanadoo.fr

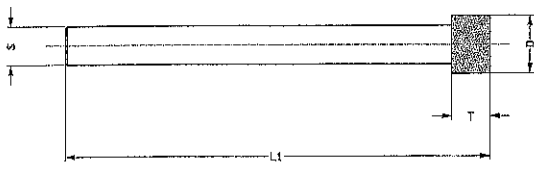

# SNDPI

SNDPI. Zone Artisanale " Les Galinoux - 24100 CREYSSE  
M. AUSTONI Christian 06. 09. 71. 22. 25 // 06. 03. 96. 56.14

TEL: (33) 05 53 57 70 52 FAX: (33) 05 53 57 12 90

GROUPE AUSTONI



**SNDPI**



D (mm)	T (mm)	U (mm)	
10	5,0	5	
10	10,0	10	
12	10,0	10	
15	10,0	8	D/B 91
15	12,0	10	D/B 126
20	12,0	10	D/B 151
30	12,0	10	D/B 252
30	17,0	15	
40	12,0	10	
50	17,0	15	

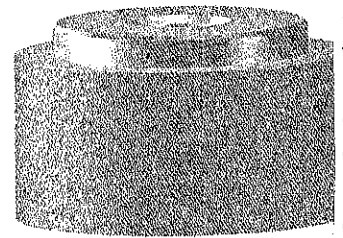
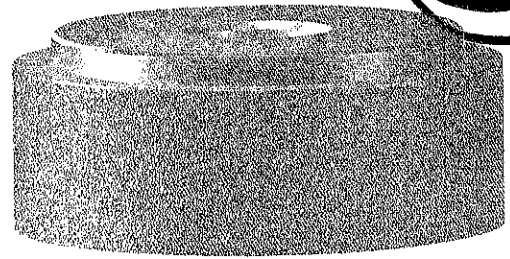

[christian.austoni@wanadoo.fr](mailto:christian.austoni@wanadoo.fr)

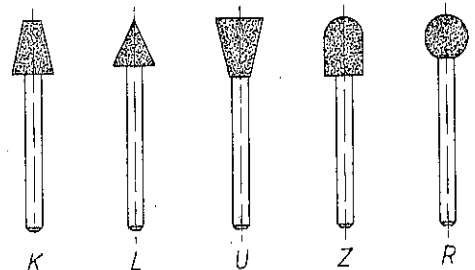
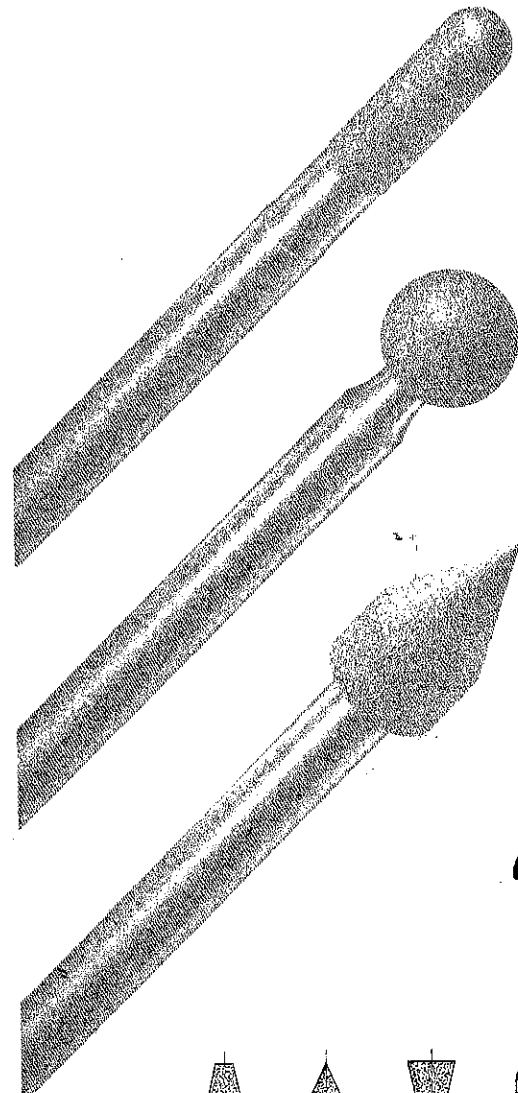
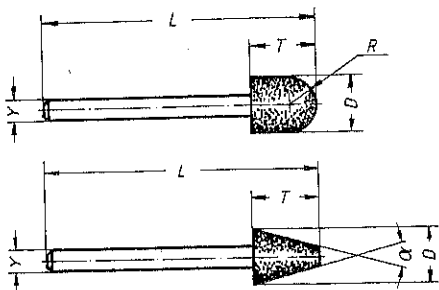
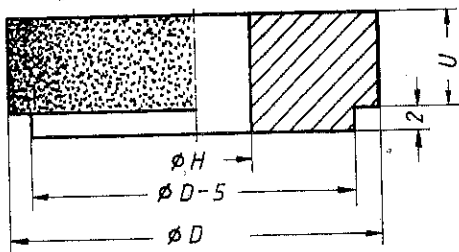

TEL: (33) 05 53 57 70 52

FAX: (33) 05 53 57 12 90

M. AUSTONI Christian 06. 09. 71. 22. 25 // 06. 03. 96. 56. 14

# SNDPI

# GROUPE AUSTONI

Meulettes pour interieur

Rodoir à profil



D (mm)	T (mm)	U (mm)	Grains
10	5,0	5	
10	10,0	10	
12	10,0	10	
15	10,0	8	D/B 91
15	12,0	10	D/B 126
20	12,0	10	D/B 151
30	12,0	10	D/B 252
30	17,0	15	
40	12,0	10	
50	17,0	15	

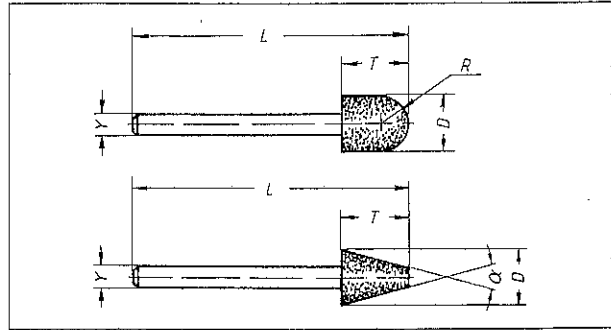

# SNDPI

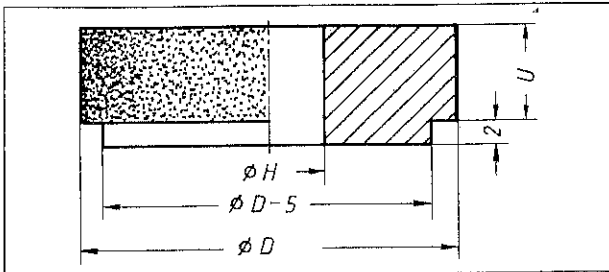
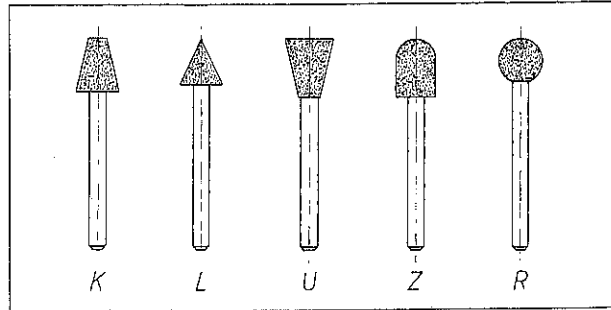

# SNDPI

christian.austoni@wanadoo.fr

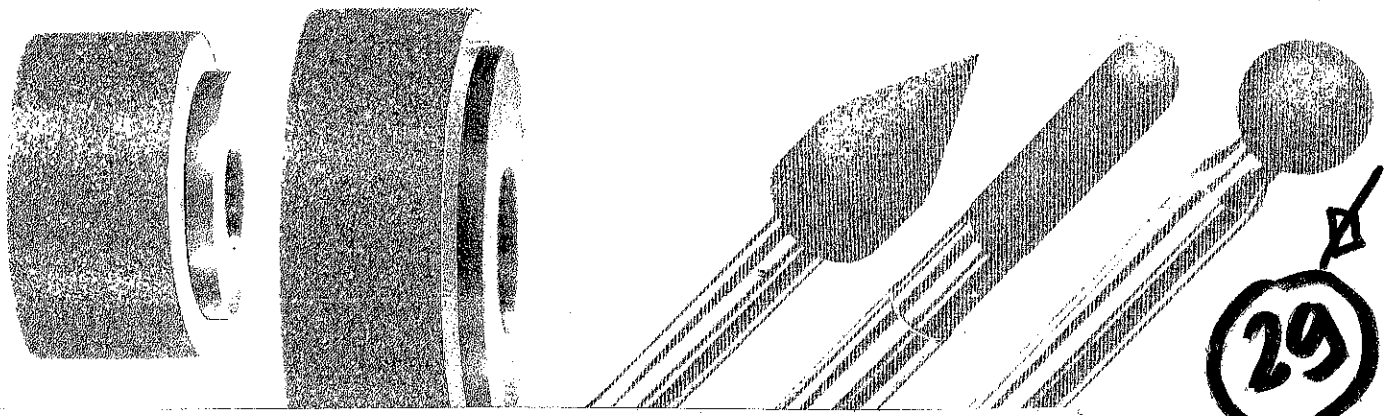

SNDPI. Zone Artisanale " Les Galinoux - 24100 CREYSSE  
 M. AUSTONI Christian 06. 09. 71. 22. 25 // 06. 03. 96. 56.14

TEL: (33) 05 53 57 70 52 FAX: (33) 05 53 57 12 90

christian.austoni@wanadoo.fr

**29.A**

GROUPPE AUSTONI

**SNDPI**

Type 2

Type 1

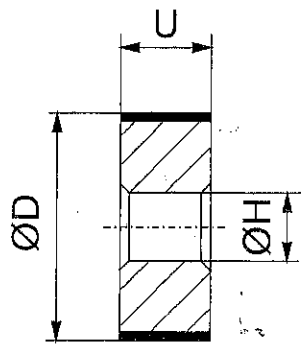

(electroplated nickel bond)

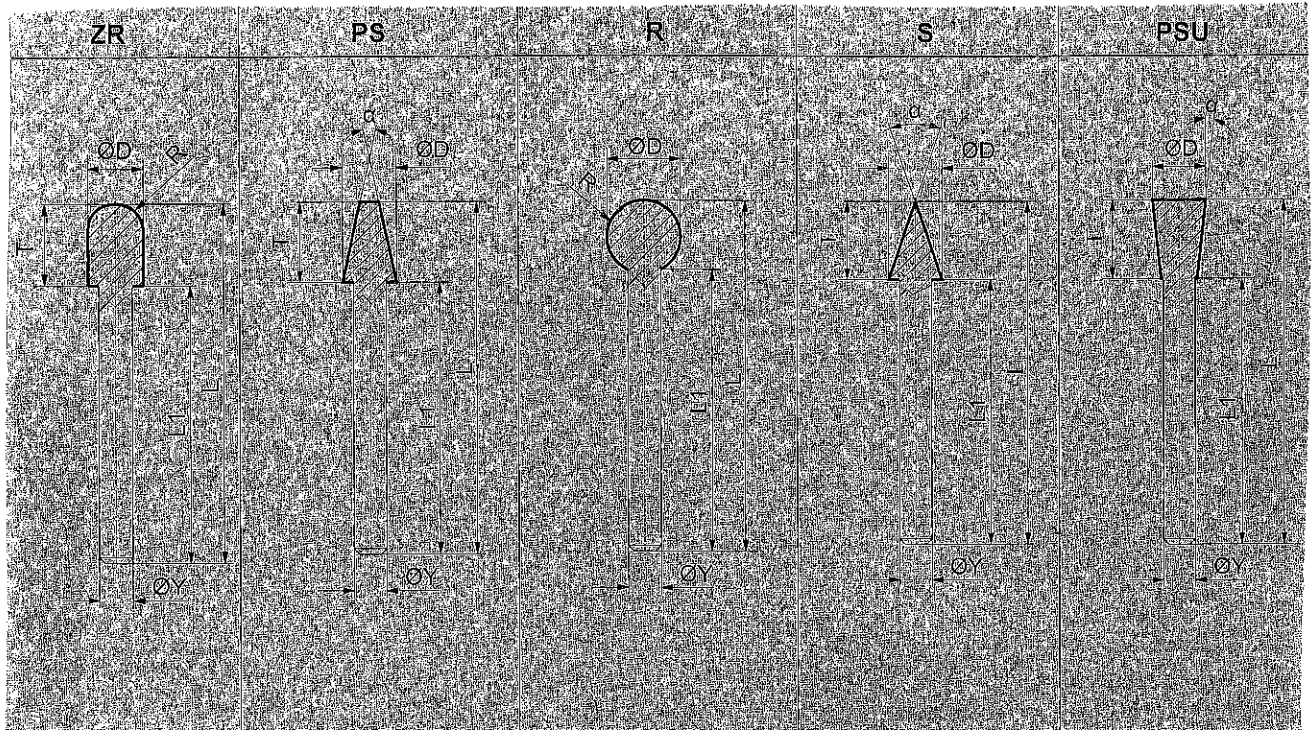
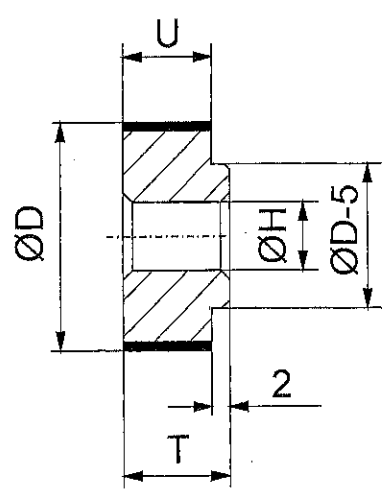

Shape	Diameter	Dimensions
ZR	D	R-T-Øy-L1-L
PS	D	α-T-Øy-L1-L
R	D	R-Øy-L1-L
S	D	α-T-Øy-L1-L
PSU	D	α-T-Øy-L1-L

**SNDPI**

**29.A**

[christian.austoni@wanadoo.fr](mailto:christian.austoni@wanadoo.fr)



**SNDPI, Zone Artisanale " Les Galinoux - 24100 CREYSSE**  
**M. AUSTONI Christian 06. 09. 71. 22. 25 // 06. 03. 96. 56.14**

**TEL: (33) 05 53 57 70 52 FAX: (33) 05 53 57 12 90**

GROUPE AUSTONI

**SNDPI**

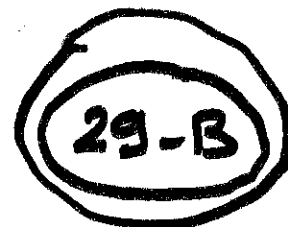

Type 1

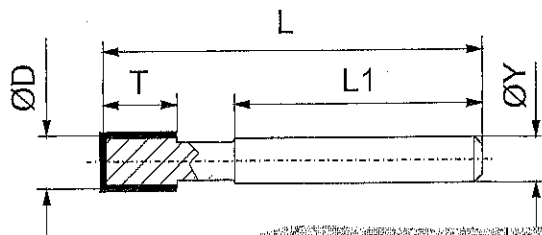

Type 2

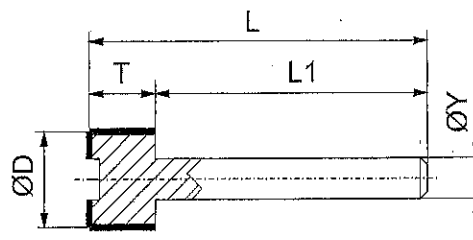

Shape	D [mm]	T [mm]	Y [mm]	L [mm]	L1 [mm]	Type
1A1W	0.5	2	3	40	33	1
1A1W	0.6	2	3	40	33	1
1A1W	0.6	4	3	40	33	1
1A1W	0.7	2	3	40	33	1
1A1W	0.7	4	3	40	33	1
1A1W	0.8	2	3	40	31	1
1A1W	0.8	4	3	40	31	1
1A1W	0.9	4	3	40	31	1
1A1W	1.0	4	3	40	31	1
1A1W	1.2	4	3	40	28	1
1A1W	1.6	4	3	40	28	1
1A1W	1.7	4	3	40	28	1
1A1W	2.0	4	3	40	24	1
1A1W	2.5	4	3	40	24	1
1A1W	3.0	5	3	40	20	1
1A1W	3.5	5	3	50	45	2
1A1W	4.0	5	3	50	45	2
1A1W	4.5	5	3	50	45	2
1A1W	5.0	7	3	50	43	2
1A1W	6.0	7	6	60	40	1
1A1W	6.0	7	6	80	60	1
1A1W	7.0	8	6	60	52	2
1A1W	7.0	8	6	80	72	2
1A1W	8.0	10	6	60	50	2
1A1W	8.0	10	6	80	70	2
1A1W	10.0	10	6	60	50	2
1A1W	10.0	10	6	80	70	2
1A1W	12.0	10	6	60	50	2
1A1W	12.0	10	6	80	70	2
1A1W	15.0	10	6	60	50	2
1A1W	15.0	10	6	80	70	2

**SNDPI**

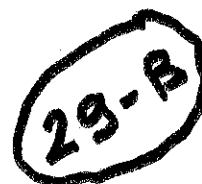

[christian.austoni@wanadoo.fr](mailto:christian.austoni@wanadoo.fr)

SNDPI. Zone Artisanale " Les Galinoux - 24100 CREYSSE  
 M. AUSTONI Christian 06. 09. 71. 22. 25 // 06. 03. 96. 56.14

TEL: (33) 05 53 57 70 52 FAX: (33) 05 53 57 12 90





GROUPE AUSTONI

**SNDPI**

29-C

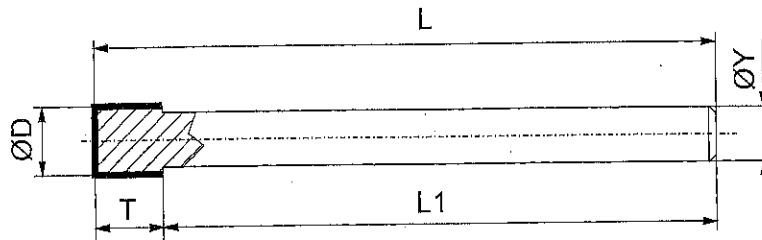

Shape	D [mm]	T [mm]	Y [mm]	L [mm]	L1 [mm]
1A1W	3.0	5	3.0	70	49
1A1W	3.5	5	3.0	75	70
1A1W	4.0	5	3.5	75	70
1A1W	4.5	6	4.0	75	69
1A1W	5.0	7	4.5	75	68
1A1W	5.5	7	5.0	75	68
1A1W	6.0	8	5.5	80	72
1A1W	6.5	8	6.0	80	72
1A1W	7.5	8	6.0	80	72
1A1W	8.0	8	6.0	80	72
1A1W	8.5	8	6.0	80	72
1A1W	9.0	10	8.0	100	90
1A1W	9.5	10	8.0	100	90
1A1W	10.0	10	8.0	100	90
1A1W	11.0	10	10.0	110	100
1A1W	12.0	10	10.0	110	100
1A1W	13.0	10	10.0	110	100
1A1W	14.0	10	10.0	110	100
1A1W	15.0	10	10.0	110	100

[christian.austoni@wanadoo.fr](mailto:christian.austoni@wanadoo.fr)



**SNDPI. Zone Artisanale " Les Galinoux - 24100 CREYSSE**  
**M. AUSTONI Christian 06. 09. 71. 22. 25 // 06. 03. 96. 56.14**

**TEL: (33) 05 53 57 70 52 FAX: (33) 05 53 57 12 90**





29-C

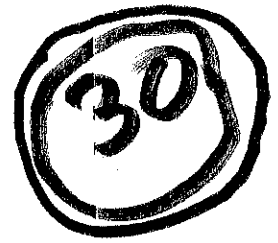

# GROUPE AUSTONI

# SNDPI



Form Shape	D mm	T mm	S mm
	1,0		2,35
	1,2		2,35
	1,4		2,35
	1,6		2,35
	1,8		2,35
	2,1		2,35
	2,3		2,35
	2,7		2,35
	3,3		2,35
	1,2	3,5	2,35
	1,4	3,5	2,35
	1,6	4,0	2,35
	1,6	7,0	2,35
	2,3	7,0	2,35
	2,7	7,0	2,35
	1,8	6,0	2,35
	1,6	8,0	2,35
	2,3	8,0	2,35
	2,1	10,0	2,35
	1,0	3,5	2,35
	1,6	5,0	2,35
	1,6	8,0	2,35
	1,6	10,0	2,35
	2,4	9,0	2,35
	5,0	1,0	2,35

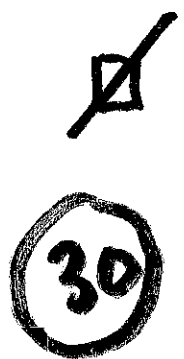
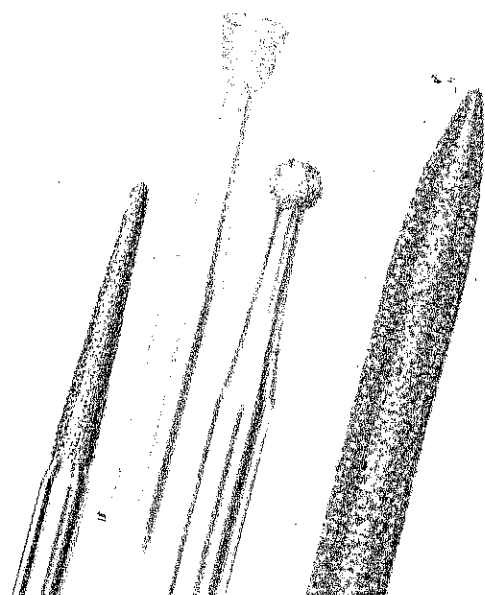
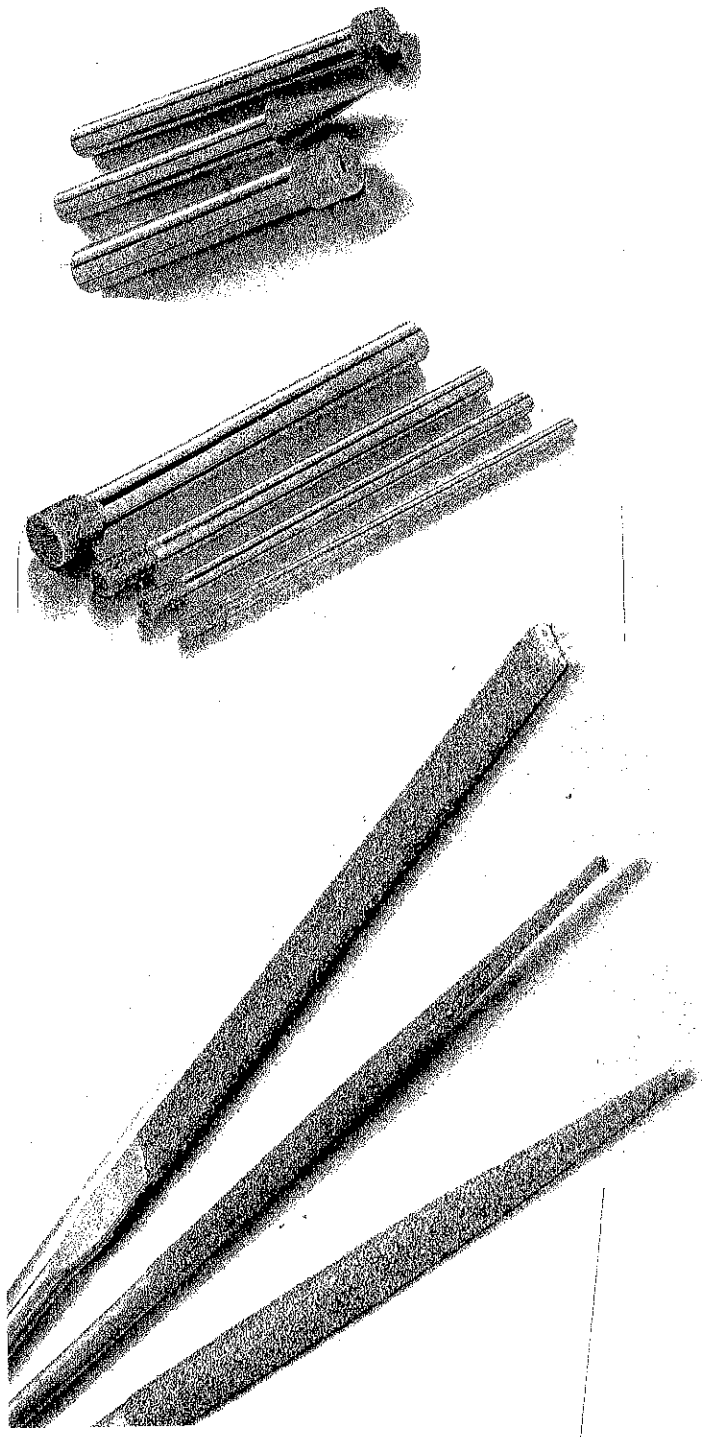
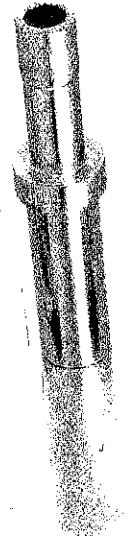

[christian.austoni@wanadoo.fr](mailto:christian.austoni@wanadoo.fr)

SNDPI. Zone Artisanale " Les Galinoux - 24100 CREYSSE  
 M. AUSTONI Christian 06. 09. 71. 22. 25 // 06. 03. 96. 56.14

TEL: (33) 05 53 57 70 52 FAX: (33) 05 53 57 12 90

# SNDPI

# GRUPE AUSTONI

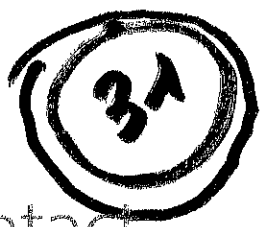

## Rifloirs

## Limes pour contact



(mm)

28 13 032		fachstumpf hand plate	2,9 x 1,8
28 33 032		dreikant three square triangulaire	2,2 x 2,2
28 43 025		vierkant square rectangulaire	2,0 x 2,0
28 92 040		Vogelzunge, gerade oval, straight ovale, droite	3,2 x 1,7
28 93 032		Vogelzunge, gebogen oval, curved ovale, pliée	3,3 x 1,6
28 62 032		rund, gerade round, straight ronde, droite	2,0
28 62 040		rund, gebogen round, curved ronde, pliée	2,0

29 01 020	
29 02 020	

# SNDPI

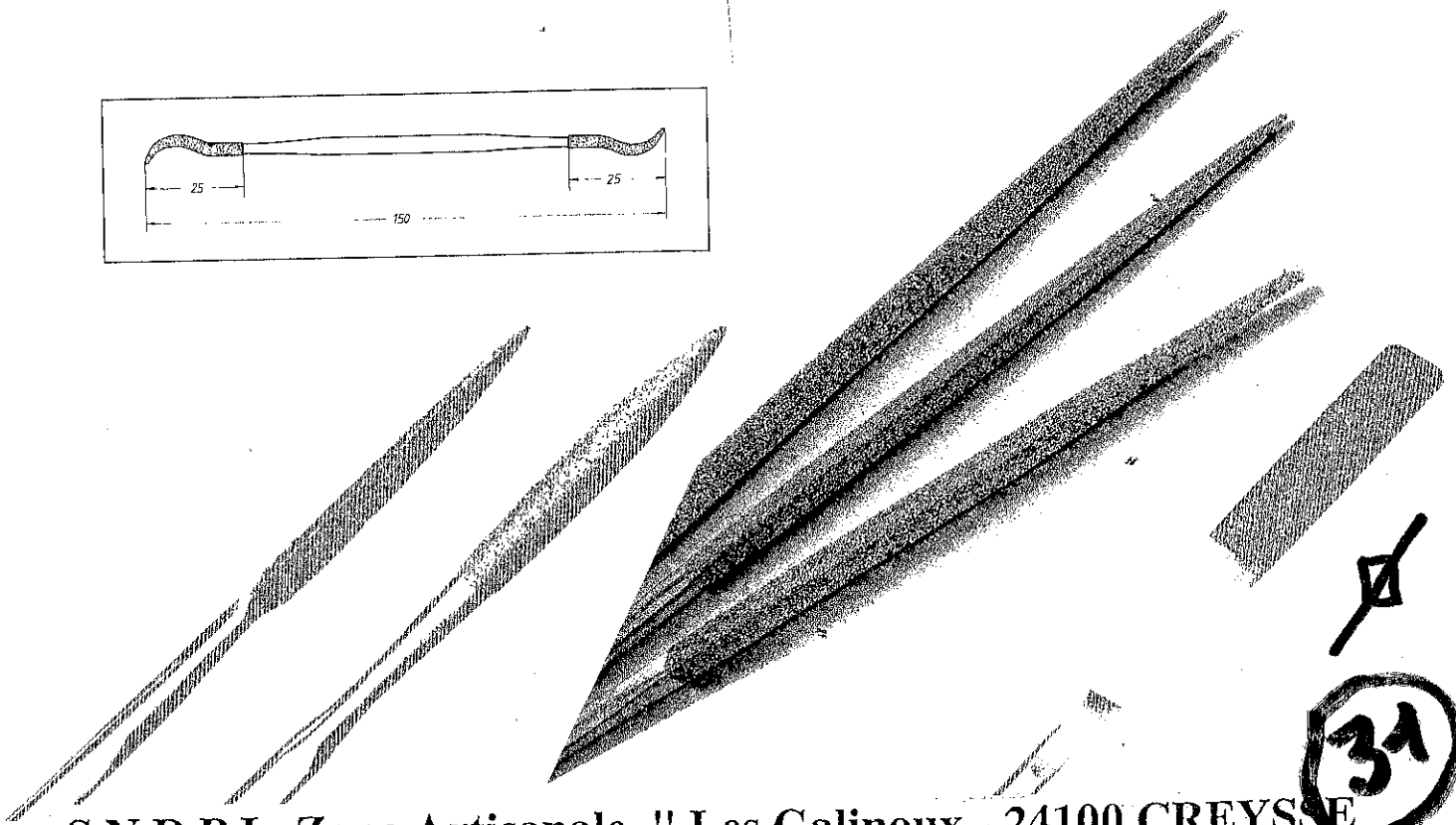
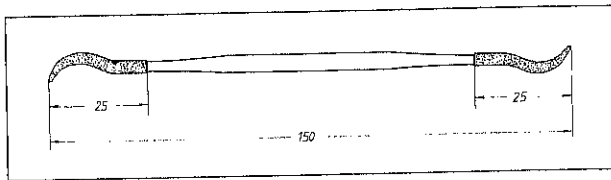
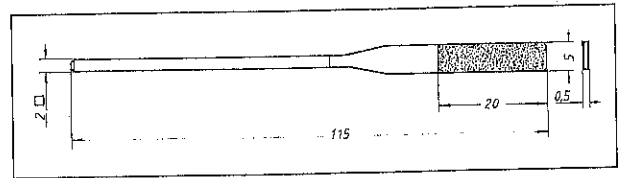











**SNDPI. Zone Artisanale " Les Galinoux - 24100 CREYSSE  
M. AUSTONI Christian 06. 09. 71. 22. 25 // 06. 03. 96. 56.14**

**TEL: (33) 05 53 57 70 52 FAX: (33) 05 53 57 12 90**

GROUPE AUSTONI

**SNDPI**



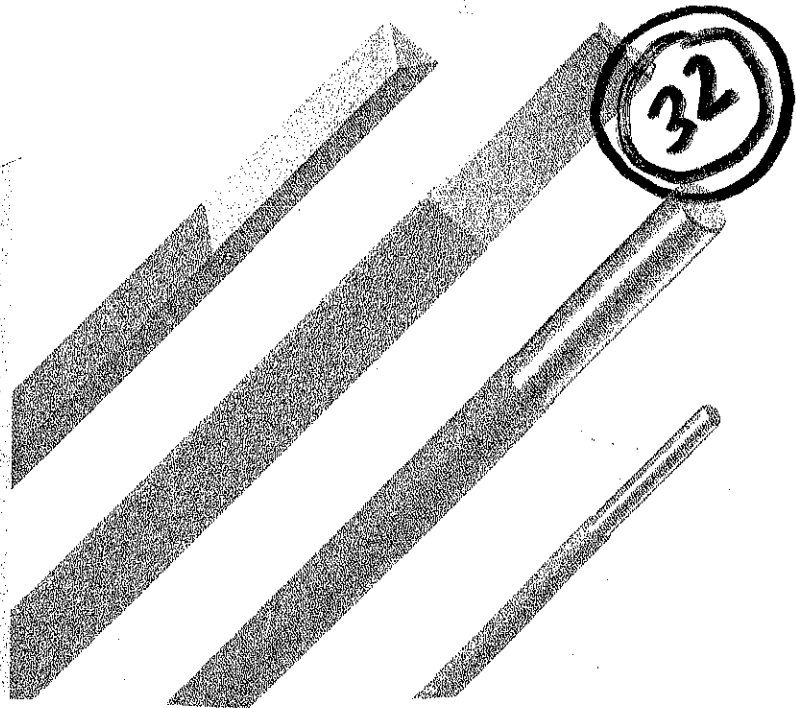

21 02 070		4,8 x 1,8
21 12 070		* 4,8 x 1,1
21 15 070		* 4,8 x 1,1
21 22 070		4,8 x 1,1
21 32 070		2,8 x 2,8
21 42 070		2,4 x 2,4
21 52 070		5,1 x 1,7
21 62 070		2,9
21 72 070		5,5 x 1,6
21 82 070		4,7 x 2,0
21 92 070		4,6 x 1,8

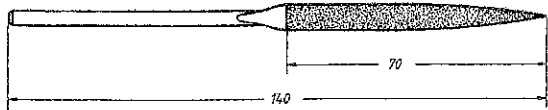

TEL: (33) 05 53 57 70 52

FAX: (33) 05 53 57 12 90



Order-No.	Profile	Dimensions of blank (mm)	(mm)	(mm)
23 12 020		2,1 x 1,0	60	100
23 12 040		4,0 x 2,0	80	125
23 12 050		5,0 x 2,0	80	150
23 12 100		9,9 x 3,7	80	150
23 12 110		10,6 x 3,8	100	200
23 32 035		3,2	80	125
23 32 060		6,0	80	150
23 32 080		7,6	80	150
23 32 100		9,6	120	200
23 42 020		1,9	60	100
23 42 030		2,8	80	125
23 42 040		3,7	80	125
23 42 050		4,9	80	150
23 42 080		7,7	80	150
23 42 100		9,7	120	200
23 52 050		4,9 x 2,5	80	125
23 52 080		7,9 x 3,7	80	150
23 52 100		9,9 x 4,7	120	200
23 62 020		2,0	60	125
23 62 030		3,0	80	125
23 62 050		5,0	80	125
23 62 060		6,0	80	150
23 62 100		9,4	120	200

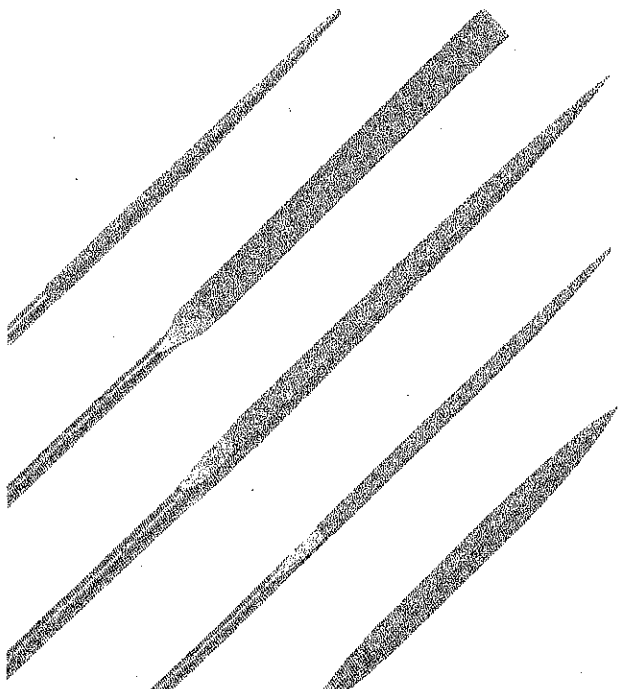

**SNDPI**

32

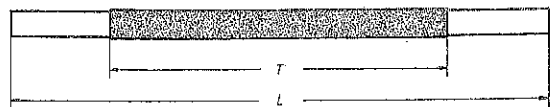

# SNDPI

# GROUPE AUSTONI



	(mm)	T (mm)	L (mm)
	1,9 x 0,8	15	50
	2,7 x 0,8	15	50
	3,8 x 0,8	15	50
	5,0 x 2,0	15	50
	5,0 x 1,7	25	60
	1,9 x 0,8	15	50
	2,7 x 0,8	15	50
	3,8 x 0,8	15	50
	5,0 x 2,0	15	50
	5,0 x 1,7	25	60
	1,9 x 0,8	15	50
	2,7 x 0,8	15	50
	3,8 x 0,8	15	50
	5,0 x 2,0	15	50
	5,0 x 1,7	25	60
	1,9	15	50
	3,1	15	50
	4,5	15	50
	3,1	25	60
	4,5	25	60
	1,4	15	50
	1,8	15	50
	2,7	15	50
	3,8	15	50
	4,9	15	50
	3,8	25	60
	4,9	25	60
	1,0	15	50
	2,0	15	50
	3,0	15	50
	4,0	15	50
	2,0	25	60
	3,0	25	60
	4,0	25	60
	1,1 x 3,8	15	50
	1,9 x 5,9	15	50
	1,9 x 6,1	25	60

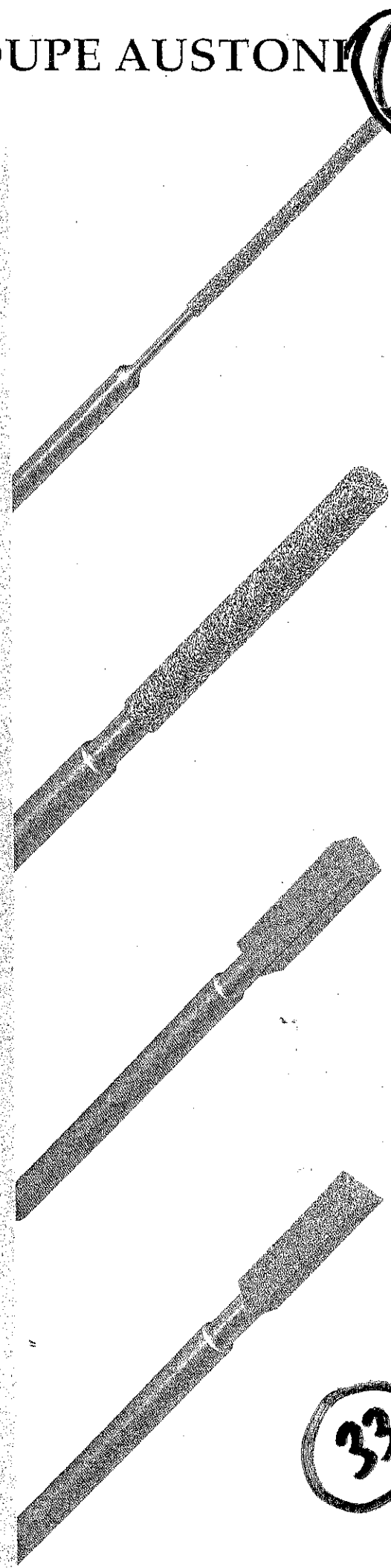

SNDPI - Zone Artisanale " Les Galinoux - 24100 CREYSSE  
M. AUSTONI Christian 06. 09. 71. 22. 25 // 06. 03. 96. 56.14

TEL: (33) 05 53 57 70 52  
FAX: (33) 05 53 57 12 90

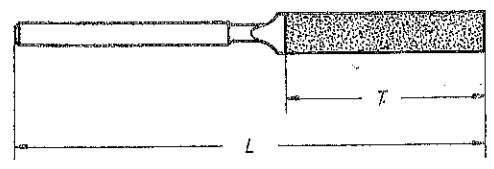

[christian.austoni@wanadoo.fr](mailto:christian.austoni@wanadoo.fr)

# SNDPI

GRUPE AUSTONI

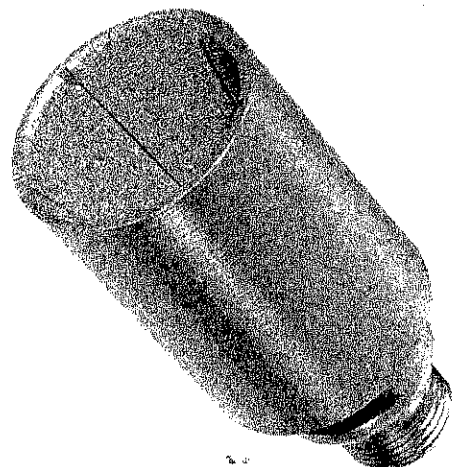
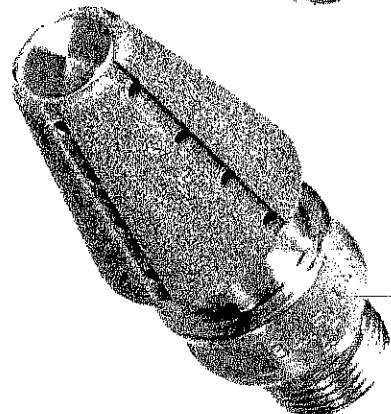
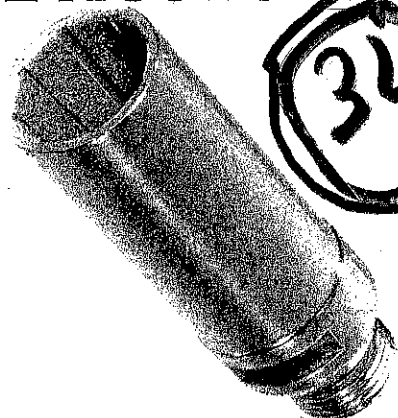

D1 (mm)	D2 (mm)	T (mm)		
11,5	4,5	50	2	2
12,0	5,0	50	2	2
13,0	6,0	50	3	2
14,0	7,0	50	3	2
15,0	8,0	50	3	3
16,0	9,0	50	3	3
17,0	10,0	50	3	3
18,0	11,0	50	3	3
19,0	12,0	50	3	3
20,0	13,0	50	5	3
21,0	14,0	50	5	3
22,0	15,0	50	5	3
23,0	16,0	50	5	3
24,0	17,0	50	5	3
25,0	18,0	50	5	3
26,0	19,0	50	5	3
27,0	20,0	50	5	3
28,0	21,0	50	7	3
29,0	22,0	50	7	3
30,0	23,0	50	7	3
31,0	24,0	50	7	3
32,0	25,0	50	7	3

# SNDPI

D1 (mm)	D2 (mm)	T (mm)		
11,7	7,5	30	3	3
12,7	8,5	30	5	3
13,7	9,5	30	5	3
14,7	10,5	30	5	3
15,7	11,5	30	5	3
16,7	12,5	30	5	3
17,7	13,5	30	5	3
18,7	14,5	30	5	3
19,5	15,5	50	5	3
20,5	16,5	50	5	3
21,5	17,5	50	5	3
22,5	18,5	50	5	3
23,5	19,5	50	5	3
24,5	20,5	50	5	3
25,5	21,5	50	5	3
26,5	22,5	50	5	3
27,5	23,5	50	5	3
28,5	24,5	50	7	3
29,5	25,5	50	7	3
30,5	26,5	50	7	3
31,5	27,5	50	7	3
32,5	28,5	50	7	3

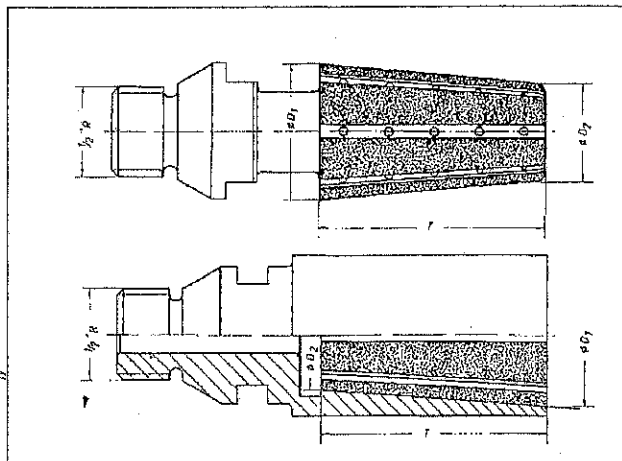

SNDPI. Zone Artisanale " Les Galinoux - 24100 CREYSSE  
 M. AUSTONI Christian 06. 09. 71. 22. 25 // 06. 03. 96. 56.14

TEL: (33) 05 53 57 70 52 FAX: (33) 05 53 57 12 90

christian.austoni@wanadoo.fr

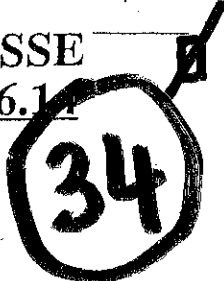



## INDEX DES FORMES

FORME	FORME
	9A3
	6A2
	11A2
	12A2 S=45
	12C9 S=45
	12V2
	12A2 S=20
	15A2
	12C9 S=20
	4A2
	6A9
	6VB5

GRUPE AUSTONI

GRUPE AUSTONI

FORME	FORME
	11V9
	12V9
	1A1
	14A1
	1V1
	3V1
	14L1
	1FF1
	14F1
	14EE1
	3E9
	4BT9
	4B9
	823
	1A1R
	1A1W
	842

SNDPI. Zone Artisanale " Les Galinoux - 24100 CREYSSE

M. AUSTONI Christian 06. 09. 71. 22. 25 // 06. 03. 96. 56.14

TEL: (33) 05 53 57 70 52 FAX: (33) 05 53 57 12 90

christian.austoni@wanadoo.fr



**SNDPI - ZALES GALINOX - 24100 CREYSSE**  
**TEL : 05 53 57 70 52 FAX : 05 53 57 12 90 TARIFF 2014**

REFERENCE	DIAMETRE	L2	T	LONGUEUR	PUHT €
FTLC0.9	0.9	10	5	57	62.97
FTLC1.0	1.0	10	5	57	62.97
FTLC1.1	1.1	10	5	57	62.97
FTLC1.2	1.2	13	5	57	62.97
FTLC1.3	1.3	13	5	57	62.97
FTLC1.4	1.4	13	5	57	62.97
FTLC1.5	1.5	13	5	57	62.97
FTLC1.6	1.6	13	5	57	62.97
FTLC1.7	1.7	13	5	57	62.97
FTLC1.8	1.8	15	5	57	62.97
FTLC1.9	1.9	15	5	57	62.97
FTLC2.0	2.0	15	5	57	65.73
FTLC2.1	2.1	17	5	57	65.73
FTLC2.2	2.2	17	5	57	65.73
FTLC2.3	2.3	17	5	57	65.73
FTLC2.4	2.4	17	5	57	65.73
FTLC2.5	2.5	17	5	57	65.73
FTLC2.6	2.6	20	5	57	69.93
FTLC2.7	2.7	20	5	57	69.93
FTLC2.8	2.8	20	5	57	69.93
FTLC2.9	2.9	20	5	57	69.93
FTLC3.0	3.0	23	5	57	69.93

**FORETS TIGES LISSES OU FILETES M4 CREUX AVEC EJECTEUR**

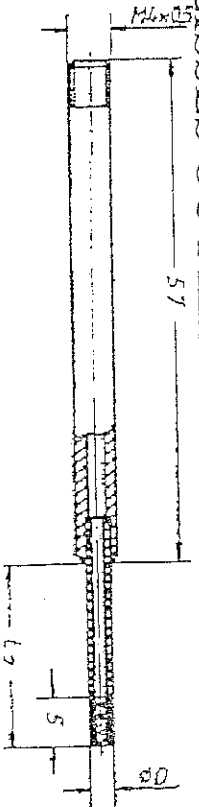

**SNDPI**

**GROUPE AUSTONI**

Zi de Creysse - Les Galinoux - 24100 CREYSSE - Tel (33) 05 53 57 70 52 - Fax (33) 05 53 57 12 90

**Christian AUSTONI**

06 09 71 22 25 / 06 03 96 56 14 - christian.austoni@wanadoo.fr

Société au capital de 75 224 euros - FR 09 377 615 136



**SNDPI - ZA LES GALINOUX - 24100 GREYSSE**  
**TEL : 05 53 57 70 52 FAX : 05 53 57 12 90 TARIF 2014**

REFERENCE	DIAMETRE	L2	T	LONGUEUR	PURT €
FTLC3.1	3.1	23	5	57	72.11
FTLC3.2	3.2	23	5	57	72.11
FTLC3.3	3.3	23	5	57	72.11
FTLC3.4	3.4	23	5	57	72.11
FTLC3.5	3.5	23	5	57	72.11
FTLC3.6	3.6	23	5	57	76.13
FTLC3.7	3.7	23	5	57	76.13
FTLC3.8	3.8	23	5	57	76.13
FTLC3.9	3.9	23	5	57	76.13
FTLC4.0	4.0	25	5	57	76.13
FTLC4.1	4.1	25	5	57	78.21
FTLC4.2	4.2	25	5	57	78.21
FTLC4.3	4.3	25	5	57	78.21
FTLC4.4	4.4	25	5	57	78.21
FTLC4.5	4.5	25	5	57	78.21
FTLC4.6	4.6	25	5	57	80.73
FTLC4.7	4.7	25	5	57	80.73
FTLC4.8	4.8	25	5	57	80.73
FTLC4.9	4.9	25	5	57	80.73
FTLC5.0	5.0	30	5	57	80.73

**FORTS TIGES LISSES OU FILETES M4 CREUX AVEC EJECTEUR**

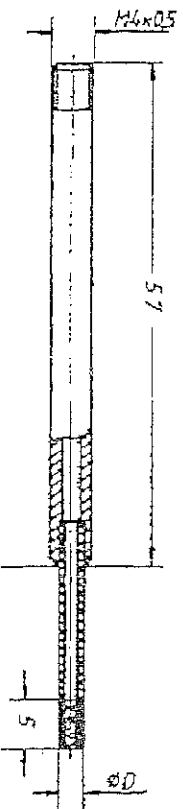

**GROUPE AUSTONI**

Zone Artisanale "Les Galinoux" - 24100 GREYSSE - Tél. (33) 05 53 57 70 52 - Fax (33) 05 53 57 12 90

Christian AUSTONI

06 09 71 22 25 / 06 03 96 56 14 - christian.austoni@wanadoc.fr

serl au capital de 76 224 euros - FR 09 377 619 186

**12 20 20 20**



**SNDPI - ZALES GALINOUX - 24100 CREYSSE**  
**TEL : 05 53 57 70 52 FAX : 05 53 57 12 90 TARIF 2014**

REFERENCE	DIAMETRE	L2	T	LONGUEUR	PUHT €
FTLC5.1	5.1	30	5	57	87.36
FTLC5.2	5.2	30	5	57	87.36
FTLC5.3	5.3	30	5	57	87.36
FTLC5.4	5.4	30	5	57	87.36
FTLC5.5	5.5	30	5	57	87.36
FTLC5.6	5.6	30	5	57	87.36
FTLC5.7	5.7	30	5	57	87.36
FTLC5.8	5.8	30	5	57	87.36
FTLC5.9	5.9	30	5	57	87.36
FTLC6.0	6.0	30	5	57	87.36
FTLC6.1	6.1	30	5	57	87.36
FTLC6.2	6.2	30	5	57	87.36
FTLC6.3	6.3	30	5	57	87.36
FTLC6.4	6.4	30	5	57	87.36
FTLC6.5	6.5	30	5	57	87.36
FTLC6.6	6.6	30	5	57	87.36
FTLC6.7	6.7	30	5	57	87.36
FTLC6.8	6.8	30	5	57	87.36
FTLC6.9	6.9	30	5	57	87.36

Remise de 3 % pour 5 pièces du même diamètre

5% pour 10 pièces du même diamètre

Remise de 10 % pour 35 pièces du même diamètre

12 % pour 36 pièces et + du même diamètre

**FORETS TIGES LISSES OU FILETES M4 CREUX AVEC EJECTEUR**

